

# SCREWS, BOLTS, AND THREADED ROD

**PROTECT**

**INSULATE**

**ISOLATE**

## ROUND - CODE "R"

Thread Size	632	832	1032	1/4-20
Head diameter	.255	.300	.340	.450
Head height	.095	.120	.130	.165

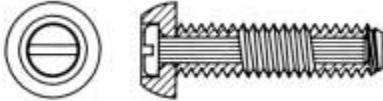

## ROUND WASHER - CODE "W"

Thread Size	632	832	1032	1/4-20
Head diameter	.230	.265	.315	.460
Head height	.100	.110	.130	.175
Washer thickness	.025	.032	.036	.056
Washer diameter	.300	.370	.425	.550



## FILLISTER - CODE "F"

Thread Size	632	832	1032	1/4-20
Head diameter	.225	.260	.300	.400
Head height	.135	.140	.160	.220

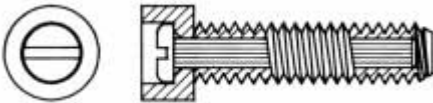

## 82° FLAT - CODE "A"

Thread Size	632	832	1032	1/4-20
Head diameter	.265	.305	.365	.510
Head height	.085	.100	.120	.155

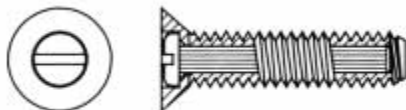

**NOTE: SPECIFY HEAD STYLE CODE LETTER.**

**EXAMPLE: 632 X 1/2" ROUND HEAD=390632R050**

**The shear strength of heat-treated steel.**  
**The Dielectric insulation, corrosion resistance**  
**and vibration resistance of nylon.**

**A perfect combination to replace:**

- \*costly brass and stainless steel fasteners.
- \*costly multiple component insulated screw assemblies.
- \*costly sleeved and clad screws.
- \*marginal standard nylon fastener applications.

Metal Core Screws are recommended in applications requiring electrical, thermal and vibration insulation in shear or double shear connections.

These reinforced screws will provide up to 4 times strength of standard nylon fasteners.

**NYLON SHELL**

Nylon 66 Natural  
 High dielectric resistance  
 Corrosion resistant  
 Vibration, abrasion resistant

**REINFORCING CORE**

\*High strength, high carbon C.H.Q. steel.  
 \*Precision cold formed and knurled.  
 \*Electro zinc or cadmium plated.

The reinforcing core incorporates a recessed metal head that permits tightening with high speed, high torque automatic drives.

Due to the corrosion resistant nature of the nylon, the Metal core Screws can, in certain applications, replace expensive stainless steel, brass and Monel fasteners at a substantial cost savings.

The insulating quality of the nylon shell makes the Metal Core Screws an ideal choice for areas where cathodic or thermal transfer is a problem.

ITEM NUMBER	SIZE	DESCRIPTION
390632 025	632 1/4 (6,35)	Metal Core
390632 037	632 3/8 (9,53)	Metal Core
390632 050	632 1/2 (12,70)	Metal Core
390832 037	832 3/8 (9,53)	Metal Core
390832 050	832 1/2 (12,70)	Metal Core
391032 037	1032 3/8 (9,53)	Metal Core
391032 050	1032 1/2 (12,70)	Metal Core
391032 075	1032 3/4 (19,05)	Metal Core
391032 100	1032 1 (25,40)	Metal Core
392520 037	1/4-20 3/8 (9,53)	Metal Core
392520 050	1/4-20 1/2 (12,70)	Metal Core
392520 062	1/4-20 5/8 (15,88)	Metal Core
392520 075	1/4-20 3/4 (19,05)	Metal Core
392520 100	1/4-20 1 (25,40)	Metal Core

**METRIC SIZES AVAILABLE ON APPLICATION**

SIZE	MAX TORQUE		TENSILE TEST		DOUBLE SHEAR	
	BEFORE DEFORMATION	ULTIMATE TORQUE	YIELD LBS.	BREAK LBS.	YIELD LBS.	BREAK LBS.
632	1 In. Lbs.	1.5 In. Lbs.	24	32	200	240
832	3 In. Lbs.	4 In. Lbs.	66	72	300	360
1032	5 In. Lbs.	6 In. Lbs.	96	104	600	640
1/4-20	12 In. Lbs.	13 In. Lbs.	120	174	1400	1600

# SCREWS, BOLTS, AND THREADED ROD

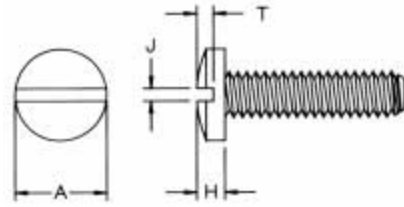

## BINDER SLOTTED HEADSTYLE

THREAD SIZE	A	H	J	T
2	.171-.181	.043-.050	.023-.031	.020-.030
4	.223-.235	.061-.068	.031-.039	.030-.042
6	.275-.290	.078-.087	.039-.048	.040-.053
8	.326-.344	.095-.105	.045-.054	.050-.065
10	.378-.399	.112-.123	.050-.060	.060-.077
12	.430-.454	.130-.141	.056-.067	.070-.089
1/4	.498-.525	.152-.165	.064-.075	.084-.105

Nominal Screw Size	0000 thru 00	0 thru 12	1/4 thru 3/4
Nominal Screw Length	Tolerance on Length		
Up to 1/2 in., incl	-0.01	-0.02	-0.03
Over 1/2 to 1 in., incl	-0.02	-0.03	-0.03
Over 1 to 2 in., incl	-	-0.06	-0.06
Over 2 in.	-	-0.09	-0.09

PART NUMBER	THREAD	LENGTH	PART NUMBER	THREAD	LENGTH	PART NUMBER	THREAD	LENGTH	PART NUMBER	THREAD	LENGTH
010256B009	256	3/32	010440B137	440	1 3/8	010832B050	832	1/2	011032B200	1032	2
010256B012	256	1/8	010440B150	440	1 1/2	010832B062	832	5/8	012520B025	1/4-20	1/4
010256B015	256	5/32	010440B162	440	1 5/8	010832B075	832	3/4	012520B031	1/4-20	5/16
010256B018	256	3/16	010440B175	440	1 3/4	010832B087	832	7/8	012520B037	1/4-20	3/8
010256B025	256	1/4	010448B025	448	1/4	010832B100	832	1	012520B050	1/4-20	1/2
010256B028	256	9/32	010632B009	632	3/32	010832B112	832	1 1/8	012520B062	1/4-20	5/8
010256B031	256	5/16	010632B012	632	1/8	010832B125	832	1 1/4	012520B075	1/4-20	3/4
010256B037	256	3/8	010632B015	632	5/32	010832B137	832	1 3/8	012520B087	1/4-20	7/8
010256B039	256	25/64	010632B018	632	3/16	010832B150	832	1 1/2	012520B100	1/4-20	1
010256B043	256	7/16	010632B025	632	1/4	010832B175	832	1 3/4	012520B125	1/4-20	1 1/4
010256B050	256	1/2	010632B031	632	5/16	010832B187	832	1 7/8	012520B150	1/4-20	1 1/2
010256B056	256	9/16	010632B037	632	3/8	010832B200	832	2	012520B175	1/4-20	1 3/4
010256B062	256	5/8	010632B043	632	7/16	011024B012	1024	1/8	012520B200	1/4-20	2
010256B075	256	3/4	010632B050	632	1/2	011024B018	1024	3/16	012520B250	1/4-20	2 1/2
010256B087	256	7/8	010632B056	632	9/16	011024B025	1024	1/4	012528B018	1/4-28	3/16
010256B100	256	1	010632B062	632	5/8	011024B031	1024	5/16	012528B025	1/4-28	1/4
010256B112	256	1 1/8	010632B068	632	11/16	011024B037	1024	3/8	012528B037	1/4-28	3/8
010264B018	264	3/16	010632B075	632	3/4	011024B050	1024	1/2	012528B062	1/4-28	5/8
010264B037	264	3/8	010632B087	632	7/8	011024B062	1024	5/8	012528B075	1/4-28	3/4
010436B050	436	1/2	010632B100	632	1	011024B075	1024	3/4	012528B100	1/4-28	1
010440B009	440	3/32	010632B112	632	1 1/8	011024B100	1024	1			
010440B012	440	1/8	010632B125	632	1 1/4	011024B125	1024	1 1/4			
010440B014	440	9/64	010632B150	632	1 1/2	011024B150	1024	1 1/2			
010440B018	440	3/16	010632B162	632	1 5/8	011032B012	1032	1/8			
010440B025	440	1/4	010632B175	632	1 3/4	011032B018	1032	3/16			
010440B028	440	9/32	010632B187	632	1 7/8	011032B025	1032	1/4			
010440B031	440	5/16	010632B200	632	2	011032B031	1032	5/16			
010440B037	440	3/8	010632B225	632	2 1/4	011032B037	1032	3/8			
010440B043	440	7/16	010640B025	640	1/4	011032B043	1032	7/16			
010440B050	440	1/2	010640B037	640	3/8	011032B050	1032	1/2			
010440B056	440	9/16	010640B075	640	3/4	011032B062	1032	5/8			
010440B062	440	5/8	010640B100	640	1	011032B075	1032	3/4			
010440B068	440	11/16	010832B012	832	1/8	011032B081	1032	13/16			
010440B075	440	3/4	010832B018	832	3/16	011032B087	1032	7/8			
010440B087	440	7/8	010832B025	832	1/4	011032B100	1032	1			
010440B100	440	1	010832B028	832	9/32	011032B106	1032	1-1/16			
010440B112	440	1 1/8	010832B031	832	5/16	011032B125	1032	1 1/4			
010440B118	440	1 3/16	010832B037	832	3/8	011032B150	1032	1 1/2			
010440B125	440	1 1/4	010832B043	832	7/16	011032B175	1032	1 3/4			



# SCREWS, BOLTS, AND THREADED ROD

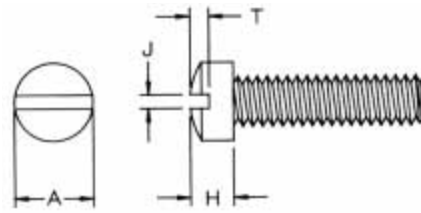

## FILLISTER SLOTTED HEADSTYLE

THREAD SIZE	A	H	J	T
2	.124-.140	.066-.083	.023-.031	.025-.037
3	.145-.161	.077-.095	.027-.035	.030-.043
4	.166-.183	.088-.107	.031-.039	.035-.048
6	.208-.226	.111-.132	.039-.048	.045-.060
8	.250-.270	.133-.156	.045-.054	.054-.071
10	.292-.313	.156-.180	.050-.060	.064-.083
12	.334-.357	.134-.148	.056-.067	.074-.094
1/4	.389-.414	.207-.237	.064-.075	.087-.109

Nominal Screw Size	0000 thru 00	0 thru 12	1/4 thru 3/4
Nominal Screw Length	Tolerance on Length		
Up to 1/2 in., incl	-0.01	-0.02	-0.03
Over 1/2 to 1 in., incl	-0.02	-0.03	-0.03
Over 1 to 2 in., incl	-	-0.06	-0.06
Over 2 in.	-	-0.09	-0.09

PART NUMBER	THREAD	LENGTH	PART NUMBER	THREAD	LENGTH	PART NUMBER	THREAD	LENGTH	PART NUMBER	THREAD	LENGTH
010256F009	256	3/32	010440F056	440	9/16	010640F037	640	3/8	011032F050	1032	1/2
010256F012	256	1/8	010440F062	440	5/8	010640F075	640	3/4	011032F062	1032	5/8
010256F015	256	5/32	010440F068	440	11/16	010640F100	640	1	011032F075	1032	3/4
010256F018	256	3/16	010440F075	440	3/4	010832F012	832	1/8	011032F081	1032	13/16
010256F025	256	1/4	010440F087	440	7/8	010832F018	832	3/16	011032F087	1032	7/8
010256F028	256	9/32	010440F100	440	1	010832F025	832	1/4	011032F100	1032	1
010256F031	256	5/16	010440F112	440	1 1/8	010832F028	832	9/32	011032F106	1032	1 1/16
010256F037	256	3/8	010440F118	440	1 3/16	010832F031	832	5/16	011032F125	1032	1 1/4
010256F039	256	25/64	010440F125	440	1 1/4	010832F037	832	3/8	011032F150	1032	1 1/2
010256F043	256	7/16	010440F137	440	1 3/8	010832F043	832	7/16	011032F175	1032	1 3/4
010256F050	256	1/2	010440F150	440	1 1/2	010832F050	832	1/2	011032F200	1032	2
010256F056	256	9/16	010440F162	440	1 5/8	010832F062	832	5/8	012520F025	1/4-20	1/4
010256F062	256	5/8	010440F175	440	1 3/4	010832F075	832	3/4	012520F031	1/4-20	5/16
010256F075	256	3/4	010448F025	448	1/4	010832F087	832	7/8	012520F037	1/4-20	3/8
010256F087	256	7/8	010540F037	540	3/8	010832F100	832	1	012520F050	1/4-20	1/2
010256F100	256	1	010632F009	632	3/32	010832F112	832	1 1/8	012520F062	1/4-20	5/8
010256F112	256	1 1/8	010632F012	632	1/8	010832F125	832	1 1/4	012520F075	1/4-20	3/4
010264F018	264	3/16	010632F015	632	5/32	010832F137	832	1 3/8	012520F087	1/4-20	7/8
010264F037	264	3/8	010632F018	632	3/16	010832F150	832	1 1/2	012520F100	1/4-20	1
010348F012	348	1/8	010632F025	632	1/4	010832F175	832	1 3/4	012520F125	1/4-20	1 1/4
010348F018	348	3/16	010632F031	632	5/16	010832F187	832	1 7/8	012520F150	1/4-20	1 1/2
010348F025	348	1/4	010632F037	632	3/8	010832F200	832	2	012520F175	1/4-20	1 3/4
010348F031	348	5/16	010632F043	632	7/16	011024F012	1024	1/8	012520F200	1/4-20	2
010348F037	348	3/8	010632F050	632	1/2	011024F018	1024	3/16	012520F250	1/4-20	2 1/2
010348F043	348	7/16	010632F056	632	9/16	011024F025	1024	1/4	012528F018	1/4-28	3/16
010348F050	348	1/2	010632F062	632	5/8	011024F031	1024	5/16	012528F025	1/4-28	1/4
010348F075	348	3/4	010632F068	632	11/16	011024F037	1024	3/8	012528F037	1/4-28	3/8
010356F031	356	5/16	010632F075	632	3/4	011024F050	1024	1/2	012528F062	1/4-28	5/8
010436F050	436	1/2	010632F087	632	7/8	011024F062	1024	5/8	012528F075	1/4-28	3/4
010440F009	440	3/32	010632F100	632	1	011024F075	1024	3/4	012528F100	1/4-28	1
010440F012	440	1/8	010632F112	632	1 1/8	011024F100	1024	1			
010440F014	440	9/64	010632F125	632	1 1/4	011024F125	1024	1 1/4			
010440F018	440	3/16	010632F150	632	1 1/2	011024F150	1024	1 1/2			
010440F025	440	1/4	010632F162	632	1 5/8	011032F012	1032	1/8			
010440F028	440	9/32	010632F175	632	1 3/4	011032F018	1032	3/16			
010440F031	440	5/16	010632F187	632	1 7/8	011032F025	1032	1/4			
010440F037	440	3/8	010632F200	632	2	011032F031	1032	5/16			
010440F043	440	7/16	010632F225	632	2 1/4	011032F037	1032	3/8			
010440F050	440	1/2	010640F025	640	1/4	011032F043	1032	7/16			



# SCREWS, BOLTS, AND THREADED ROD

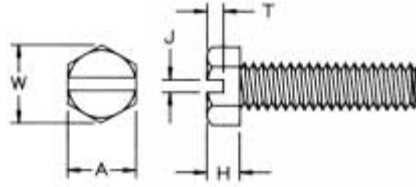

## HEX SLOTTED HEADSTYLE

THREAD SIZE	A	W	H	J	T
2	.120-.125	.134 MIN	.040-.050	.024-.032	.021-.029
4	.181-.188	.202 MIN	.049-.060	.031-.039	.025-.036
6	.244-.250	.272 MIN	.080-.093	.039-.048	.033-.046
8	.244-.250	.272 MIN	.096-.110	.045-.054	.052-.066
10	.305-.312	.340 MIN	.105-.120	.050-.060	.057-.072
12	.305-.312	.340 MIN	.139-.155	.056-.067	.077-.093
1/4	.367-.375	.409 MIN	.172-.190	.064-.075	.083-.101

Nominal Screw Size	0000 thru 00	0 thru 12	1/4 thru 3/4
Nominal Screw Length	Tolerance on Length		
Up to 1/2 in., incl	-0.01	-0.02	-0.03
Over 1/2 to 1 in., incl	-0.02	-0.03	-0.03
Over 1 to 2 in., incl	-	-0.06	-0.06
Over 2 in.	-	-0.09	-0.09

PART NUMBER	THREAD	LENGTH	PART NUMBER	THREAD	LENGTH	PART NUMBER	THREAD	LENGTH	PART NUMBER	THREAD	LENGTH
010256X009	256	3/32	010440X137	440	1 3/8	010832X050	832	1/2	011032X200	1032	2
010256X012	256	1/8	010440X150	440	1 1/2	010832X062	832	5/8	012520X025	1/4-20	1/4
010256X015	256	5/32	010440X162	440	1 5/8	010832X075	832	3/4	012520X031	1/4-20	5/16
010256X018	256	3/16	010440X175	440	1 3/4	010832X087	832	7/8	012520X037	1/4-20	3/8
010256X025	256	1/4	010448X025	448	1/4	010832X100	832	1	012520X050	1/4-20	1/2
010256X028	256	9/32	010632X009	632	3/32	010832X112	832	1 1/8	012520X062	1/4-20	5/8
010256X031	256	5/16	010632X012	632	1/8	010832X125	832	1 1/4	012520X075	1/4-20	3/4
010256X037	256	3/8	010632X015	632	5/32	010832X137	832	1 3/8	012520X087	1/4-20	7/8
010256X039	256	25/64	010632X018	632	3/16	010832X150	832	1 1/2	012520X100	1/4-20	1
010256X043	256	7/16	010632X025	632	1/4	010832X175	832	1 3/4	012520X125	1/4-20	1 1/4
010256X050	256	1/2	010632X031	632	5/16	010832X187	832	1 7/8	012520X150	1/4-20	1 1/2
010256X056	256	9/16	010632X037	632	3/8	010832X200	832	2	012520X175	1/4-20	1 3/4
010256X062	256	5/8	010632X043	632	7/16	011024X012	1024	1/8	012520X200	1/4-20	2
010256X075	256	3/4	010632X050	632	1/2	011024X018	1024	3/16	012520X250	1/4-20	2 1/2
010256X087	256	7/8	010632X056	632	9/16	011024X025	1024	1/4	012528X018	1/4-28	3/16
010256X100	256	1	010632X062	632	5/8	011024X031	1024	5/16	012528X025	1/4-28	1/4
010256X112	256	1 1/8	010632X068	632	11/16	011024X037	1024	3/8	012528X037	1/4-28	3/8
010264X018	264	3/16	010632X075	632	3/4	011024X050	1024	1/2	012528X050	1/4-28	1/2
010264X037	264	3/8	010632X087	632	7/8	011024X062	1024	5/8	012528X062	1/4-28	5/8
010436X050	436	1/2	010632X100	632	1	011024X075	1024	3/4	012528X075	1/4-28	3/4
010440X009	440	3/32	010632X112	632	1 1/8	011024X100	1024	1	012528X100	1/4-28	1
010440X012	440	1/8	010632X125	632	1 1/4	011024X125	1024	1 1/4			
010440X014	440	9/64	010632X150	632	1 1/2	011024X150	1024	1 1/2			
010440X018	440	3/16	010632X162	632	1 5/8	011032X012	1032	1/8			
010440X025	440	1/4	010632X175	632	1 3/4	011032X018	1032	3/16			
010440X028	440	9/32	010632X187	632	1 7/8	011032X025	1032	1/4			
010440X031	440	5/16	010632X200	632	2	011032X031	1032	5/16			
010440X037	440	3/8	010632X225	632	2 1/4	011032X037	1032	3/8			
010440X043	440	7/16	010640X025	640	1/4	011032X043	1032	7/16			
010440X050	440	1/2	010640X037	640	3/8	011032X050	1032	1/2			
010440X056	440	9/16	010640X075	640	3/4	011032X062	1032	5/8			
010440X062	440	5/8	010640X100	640	1	011032X075	1032	3/4			
010440X068	440	11/16	010832X012	832	1/8	011032X081	1032	13/16			
010440X075	440	3/4	010832X018	832	3/16	011032X087	1032	7/8			
010440X087	440	7/8	010832X025	832	1/4	011032X100	1032	1			
010440X100	440	1	010832X028	832	9/32	011032X106	1032	1 1/16			
010440X112	440	1 1/8	010832X031	832	5/16	011032X125	1032	1 1/4			
010440X118	440	1 3/16	010832X037	832	3/8	011032X150	1032	1 1/2			
010440X125	440	1 1/4	010832X043	832	7/16	011032X175	1032	1 3/4			





# SCREWS, BOLTS, AND THREADED ROD

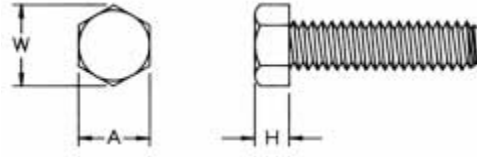

## HEX UNSLOTTED HEADSTYLE

THREAD SIZE	A	W	H
2	.120-.125	.134 min.	.040-.050
3	.181-.188	.202 min.	.044-.055
4	.181-.188	.202 min.	.049-.060
6	.244-.250	.272 min.	.080-.093
8	.244-.250	.272 min.	.096-.110
10	.305-.312	.340 min.	.105-.120
12	.305-.312	.340 min.	.139-.155
1/4	.367-.375	.409 min.	.172-.190

Nominal Screw Size	0000 thru 00	0 thru 12	1/4 thru 3/4
Nominal Screw Length	Tolerance on Length		
Up to 1/2 in., incl	-0.01	-0.02	-0.03
Over 1/2 to 1 in., incl	-0.02	-0.03	-0.03
Over 1 to 2 in., incl	-	-0.06	-0.06
Over 2 in.	-	-0.09	-0.09

PART NUMBER	THREAD	LENGTH	PART NUMBER	THREAD	LENGTH	PART NUMBER	THREAD	LENGTH	PART NUMBER	THREAD	LENGTH
010256H009	256	3/32	010440H056	440	9/16	010640H075	640	3/4	011032H062	1032	5/8
010256H012	256	1/8	010440H062	440	5/8	010640H100	640	1	011032H075	1032	3/4
010256H015	256	5/32	010440H068	440	11/16	010832H012	832	1/8	011032H081	1032	13/16
010256H018	256	3/16	010440H075	440	3/4	010832H018	832	3/16	011032H087	1032	7/8
010256H025	256	1/4	010440H087	440	7/8	010832H025	832	1/4	011032H100	1032	1
010256H028	256	9/32	010440H100	440	1	010832H028	832	9/32	011032H106	1032	1 1/16
010256H031	256	5/16	010440H112	440	1 1/8	010832H031	832	5/16	011032H125	1032	1 1/4
010256H037	256	3/8	010440H118	440	1 3/16	010832H037	832	3/8	011032H150	1032	1 1/2
010256H039	256	25/64	010440H125	440	1 1/4	010832H043	832	7/16	011032H175	1032	1 3/4
010256H043	256	7/16	010440H137	440	1 3/8	010832H050	832	1/2	011032H200	1032	2
010256H050	256	1/2	010440H150	440	1 1/2	010832H062	832	5/8	012520H025	1/4-20	1/4
010256H056	256	9/16	010440H162	440	1 5/8	010832H075	832	3/4	012520H031	1/4-20	5/16
010256H062	256	5/8	010440H175	440	1 3/4	010832H087	832	7/8	012520H037	1/4-20	3/8
010256H075	256	3/4	010448H025	448	1/4	010832H100	832	1	012520H050	1/4-20	1/2
010256H087	256	7/8	010632H009	632	3/32	010832H112	832	1 1/8	012520H062	1/4-20	5/8
010256H100	256	1	010632H012	632	1/8	010832H125	832	1 1/4	012520H075	1/4-20	3/4
010256H112	256	1 1/8	010632H015	632	5/32	010832H137	832	1 3/8	012520H087	1/4-20	7/8
010264H018	264	3/16	010632H018	632	3/16	010832H150	832	1 1/2	012520H100	1/4-20	1
010264H037	264	3/8	010632H025	632	1/4	010832H175	832	1 3/4	012520H125	1/4-20	1 1/4
010348H012	348	1/8	010632H031	632	5/16	010832H187	832	1 7/8	012520H150	1/4-20	1 1/2
010348H018	348	3/16	010632H037	632	3/8	010832H200	832	2	012520H175	1/4-20	1 3/4
010348H025	348	1/4	010632H043	632	7/16	011024H012	1024	1/8	012520H200	1/4-20	2
010348H031	348	5/16	010632H050	632	1/2	011024H018	1024	3/16	012520H250	1/4-20	2 1/2
010348H037	348	3/8	010632H056	632	9/16	011024H025	1024	1/4	012528H018	1/4-28	3/16
010348H043	348	7/16	010632H062	632	5/8	011024H031	1024	5/16	012528H025	1/4-28	1/4
010348H050	348	1/2	010632H068	632	11/16	011024H037	1024	3/8	012528H037	1/4-28	3/8
010348H075	348	3/4	010632H075	632	3/4	011024H050	1024	1/2	012528H062	1/4-28	5/8
010356H031	356	5/16	010632H087	632	7/8	011024H062	1024	5/8	012528H075	1/4-28	3/4
010436H050	436	1/2	010632H100	632	1	011024H075	1024	3/4	012528H100	1/4-28	1
010440H009	440	3/32	010632H112	632	1 1/8	011024H100	1024	1			
010440H012	440	1/8	010632H125	632	1 1/4	011024H125	1024	1 1/4			
010440H014	440	9/64	010632H150	632	1 1/2	011024H150	1024	1 1/2			
010440H018	440	3/16	010632H162	632	1 5/8	011032H012	1032	1/8			
010440H025	440	1/4	010632H175	632	1 3/4	011032H018	1032	3/16			
010440H028	440	9/32	010632H187	632	1 7/8	011032H025	1032	1/4			
010440H031	440	5/16	010632H200	632	2	011032H031	1032	5/16			
010440H037	440	3/8	010632H225	632	2 1/4	011032H037	1032	3/8			
010440H043	440	7/16	010640H025	640	1/4	011032H043	1032	7/16			
010440H050	440	1/2	010640H037	640	3/8	011032H050	1032	1/2			



# SCREWS, BOLTS, AND THREADED ROD

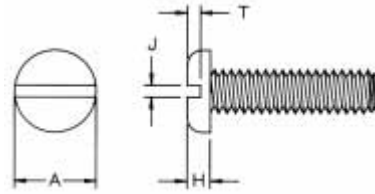

THREAD SIZE	A	H	J	T
1	.130-.142	.038-.046	.019-.026	.018-.027
2	.155-.167	.045-.053	.023-.031	.022-.031
4	.205-.219	.058-.068	.031-.039	.030-.040
6	.256-.270	.072-.082	.039-.048	.037-.050
8	.306-.322	.085-.096	.045-.054	.045-.058
10	.357-.373	.099-.110	.050-.060	.053-.068
12	.407-.425	.112-.125	.056-.067	.061-.077
1/4	.473-.492	.130-.144	.064-.075	.070-.087
5/16	.594-.615	.162-.178	.072-.084	.085-.106

Nominal Screw Size	0000 thru 00	0 thru 12	1/4 thru 3/4
	Tolerance on Length		
Up to 1/2 in., incl	-0.01	-0.02	-0.03
Over 1/2 to 1 in., incl	-0.02	-0.03	-0.03
Over 1 to 2 in., incl	-	-0.06	-0.06
Over 2 in.	-	-0.09	-0.09

## PAN SLOTTED HEADSTYLE

PART NUMBER	THREAD	LENGTH	PART NUMBER	THREAD	LENGTH	PART NUMBER	THREAD	LENGTH	PART NUMBER	THREAD	LENGTH
010164P025	164	1/4	010440P087	440	7/8	010832P025	832	1/4	011032P100	1032	1
010164P075	164	3/4	010440P100	440	1	010832P028	832	9/32	011032P106	1032	1 1/16
010172P025	172	1/4	010440P112	440	1 1/8	010832P031	832	5/16	011032P125	1032	1 1/4
010172P050	172	1/2	010440P118	440	1 3/16	010832P037	832	3/8	011032P150	1032	1 1/2
010256P006	256	1/16	010440P125	440	1 1/4	010832P043	832	7/16	011032P175	1032	1 3/4
010256P009	256	3/32	010440P137	440	1 3/8	010832P050	832	1/2	011032P200	1032	2
010256P012	256	1/8	010440P150	440	1 1/2	010832P062	832	5/8	012520P025	1/4-20	1/4
010256P015	256	5/32	010440P162	440	1 5/8	010832P075	832	3/4	012520P031	1/4-20	5/16
010256P018	256	3/16	010440P175	440	1 3/4	010832P087	832	7/8	012520P037	1/4-20	3/8
010256P025	256	1/4	010448P025	448	1/4	010832P100	832	1	012520P050	1/4-20	1/2
010256P028	256	9/32	010632P009	632	3/32	010832P112	832	1 1/8	012520P062	1/4-20	5/8
010256P031	256	5/16	010632P012	632	1/8	010832P125	832	1 1/4	012520P075	1/4-20	3/4
010256P037	256	3/8	010632P015	632	5/32	010832P137	832	1 3/8	012520P087	1/4-20	7/8
010256P039	256	25/64	010632P018	632	3/16	010832P150	832	1 1/2	012520P100	1/4-20	1
010256P043	256	7/16	010632P025	632	1/4	010832P175	832	1 3/4	012520P125	1/4-20	1 1/4
010256P050	256	1/2	010632P031	632	5/16	010832P187	832	1 7/8	012520P150	1/4-20	1 1/2
010256P056	256	9/16	010632P037	632	3/8	010832P200	832	2	012520P175	1/4-20	1 3/4
010256P062	256	5/8	010632P043	632	7/16	011024P012	1024	1/8	012520P200	1/4-20	2
010256P075	256	3/4	010632P050	632	1/2	011024P018	1024	3/16	012520P250	1/4-20	2 1/2
010256P087	256	7/8	010632P056	632	9/16	011024P025	1024	1/4	012528P018	1/4-28	3/16
010256P100	256	1	010632P062	632	5/8	011024P031	1024	5/16	012528P025	1/4-28	1/4
010256P112	256	1 1/8	010632P068	632	11/16	011024P037	1024	3/8	012528P037	1/4-28	3/8
010264P018	264	3/16	010632P075	632	3/4	011024P050	1024	1/2	012528P062	1/4-28	5/8
010264P037	264	3/8	010632P087	632	7/8	011024P062	1024	5/8	012528P075	1/4-28	3/4
010436P050	436	1/2	010632P100	632	1	011024P075	1024	3/4	012528P100	1/4-28	1
010440P009	440	3/32	010632P112	632	1 1/8	011024P100	1024	1	0131218P087	5/16-18	7/8
010440P012	440	1/8	010632P125	632	1 1/4	011024P125	1024	1 1/4			
010440P014	440	9/64	010632P150	632	1 1/2	011024P150	1024	1 1/2			
010440P018	440	3/16	010632P162	632	1 5/8	011032P012	1032	1/8			
010440P025	440	1/4	010632P175	632	1 3/4	011032P018	1032	3/16			
010440P028	440	9/32	001632P187	632	1 7/8	011032P025	1032	1/4			
010440P031	440	5/16	010632P200	632	2	011032P031	1032	5/16			
010440P037	440	3/8	010632P225	632	2 1/4	011032P037	1032	3/8			
010440P043	440	7/16	010640P025	640	1/4	011032P043	1032	7/16			
010440P050	440	1/2	010640P037	640	3/8	011032P050	1032	1/2			
010440P056	440	9/16	010640P075	640	3/4	011032P062	1032	5/8			
010440P062	440	5/8	010640P100	640	1	011032P075	1032	3/4			
010440P068	440	11/16	010832P012	832	1/8	011032P081	1032	3/16			
010440P075	440	3/4	010832P018	832	3/16	011032P087	1032	7/8			



# SCREWS, BOLTS, AND THREADED ROD

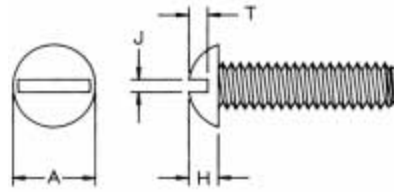

## ROUND SLOTTED HEADSTYLE

THREAD SIZE	A	H	J	T
1	.122-.138	.051-.061	.019-.026	.033-.044
2	.146-.162	.059-.069	.023-.031	.037-.048
3	.169-.187	.067-.078	.027-.035	.040-.053
4	.193-.211	.075-.086	.031-.039	.044-.058
5	.217-.236	.083-.095	.035-.043	.047-.063
6	.240-.260	.091-.103	.039-.048	.051-.068
8	.287-.309	.107-.120	.045-.054	.058-.077
10	.334-.359	.123-.137	.050-.060	.065-.087
12	.382-.408	.139-.153	.056-.067	.073-.096
1/4	.443-.472	.160-.175	.064-.075	.082-.109

Nominal Screw Size	0000 thru 00	0 thru 12	1/4 thru 3/4
Nominal Screw Length	Tolerance on Length		
Up to 1/2 in., incl	-0.01	-0.02	-0.03
Over 1/2 to 1 in., incl	-0.02	-0.03	-0.03
Over 1 to 2 in., incl	-	-0.06	-0.06
Over 2 in.	-	-0.09	-0.09

PART NUMBER	THREAD	LENGTH	PART NUMBER	THREAD	LENGTH	PART NUMBER	THREAD	LENGTH	PART NUMBER	THREAD	LENGTH
010164R025	164	1/4	010440R031	440	5/16	010632R187	632	1 7/8	011032R025	1032	1/4
010164R075	164	3/4	010440R037	440	3/8	010632R200	632	2	011032R031	1032	5/16
010172R025	172	1/4	010440R043	440	7/16	010632R225	632	2 1/4	011032R037	1032	3/8
010172R050	172	1/2	010440R050	440	1/2	010640R025	640	1/4	011032R043	1032	7/16
010256R006	256	1/16	010440R056	440	9/16	010640R037	640	3/8	011032R050	1032	1/2
010256R009	256	3/32	010440R062	440	5/8	010640R075	640	3/4	011032R062	1032	5/8
010256R012	256	1/8	010440R068	440	11/16	010640R100	640	1	011032R075	1032	3/4
010256R015	256	5/32	010440R075	440	3/4	010832R012	832	1/8	011032R081	1032	13/16
010256R018	256	3/16	010440R087	440	7/8	010832R018	832	3/16	011032R087	1032	7/8
010256R025	256	1/4	010440R100	440	1	010832R025	832	1/4	011032R100	1032	1
010256R028	256	9/32	010440R112	440	1 1/8	010832R028	832	9/32	011032R106	1032	1 1/16
010256R031	256	5/16	010440R118	440	1 3/16	010832R031	832	5/16	011032R125	1032	1 1/4
010256R037	256	3/8	010440R125	440	1 1/4	010832R037	832	3/8	011032R150	1032	1 1/2
010256R043	256	7/16	010440R137	440	1 3/8	010832R043	832	7/16	011032R175	1032	1 3/4
010256R050	256	1/2	010440R150	440	1 1/2	010832R050	832	1/2	011032R200	1032	2
010256R056	256	9/16	010440R162	440	1 5/8	010832R062	832	5/8	012520R025	1/4-20	1/4
010256R062	256	5/8	010440R175	440	1 3/4	010832R075	832	3/4	012520R031	1/4-20	5/16
010256R075	256	3/4	010448R025	448	1/4	010832R087	832	7/8	012520R037	1/4-20	3/8
010256R087	256	7/8	010540R050	540	1/2	010832R100	832	1	012520R050	1/4-20	1/2
010256R100	256	1	010632R009	632	3/32	010832R112	832	1 1/8	012520R062	1/4-20	5/8
010256R112	256	1 1/8	010632R012	632	1/8	010832R125	832	1 1/4	012520R075	1/4-20	3/4
010264R018	264	3/16	010632R015	632	5/32	010832R137	832	1 3/8	012520R087	1/4-20	7/8
010264R037	264	3/8	010632R018	632	3/16	010832R150	832	1 1/2	012520R100	1/4-20	1
010348R012	348	1/8	010632R025	632	1/4	010832R175	832	1 3/4	012520R125	1/4-20	1 1/4
010348R018	348	3/16	010632R031	632	5/16	010832R187	832	1 7/8	012520R150	1/4-20	1 1/2
010348R025	348	1/4	010632R037	632	3/8	010832R200	832	2	012520R175	1/4-20	1 3/4
010348R031	348	5/16	010632R043	632	7/16	011024R012	1024	1/8	012520R200	1/4-20	2
010348R037	348	3/8	010632R050	632	1/2	011024R018	1024	3/16	012520R250	1/4-20	2 1/2
010348R043	348	7/16	010632R056	632	9/16	011024R025	1024	1/4	012520R300	1/4-20	3
010348R050	348	1/2	010632R062	632	5/8	011024R031	1024	5/16	012528R018	1/4-28	3/16
010348R075	348	3/4	010632R068	632	11/16	011024R037	1024	3/8	012528R025	1/4-28	1/4
010356R031	356	5/16	010632R075	632	3/4	011024R050	1024	1/2	012528R037	1/4-28	3/8
010436P050	436	1/2	010632R087	632	7/8	011024R062	1024	5/8	012528R062	1/4-28	5/8
010440R009	440	3/32	010632R100	632	1	011024R075	1024	3/4	012528R075	1/4-28	3/4
010440R012	440	1/8	010632R112	632	1 1/8	011024R100	1024	1	012528R100	1/4-28	1
010440R014	440	9/64	010632R125	632	1 1/4	011024R125	1024	1 1/4			
010440R018	440	3/16	010632R150	632	1 1/2	011024R150	1024	1 1/2			
010440R025	440	1/4	010632R162	632	1 5/8	011032R012	1032	1/8			
010440R028	440	9/32	010632R175	632	1 3/4	011032R018	1032	3/16			

# SCREWS, BOLTS, AND THREADED ROD

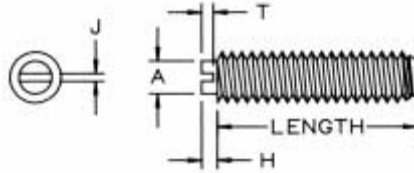

## SET SLOTTED HEADSTYLE

THREAD SIZE	A	H	J	T
2	.055	.035	.018	.020
4	.075	.045	.020	.025
6	.100	.055	.025	.030
8	.120	.055	.028	.035
10	.150	.060	.035	.050
1/4	.175	.080	.040	.060
5/16	.246	.078	.051	.078

Nominal Screw Size	0000 thru 00	0 thru 12	1/4 thru 3/4
	Tolerance on Length		
Up to 1/2 in., incl	-0.01	-0.02	-0.03
Over 1/2 to 1 in., incl	-0.02	-0.03	-0.03
Over 1 to 2 in., incl	-	-0.06	-0.06
Over 2 in.	-	-0.09	-0.09

PART NUMBER	THREAD	LENGTH	PART NUMBER	THREAD	LENGTH	PART NUMBER	THREAD	LENGTH	PART NUMBER	THREAD	LENGTH
010256S006	256	1/16	010440S125	440	1 1/4	010832S043	832	7/16	011032S200	1032	2
010256S009	256	3/32	010440S137	440	1 3/8	010832S050	832	1/2	012520S025	1/4-20	1/4
010256S012	256	1/8	010440S150	440	1 1/2	010832S062	832	5/8	012520S031	1/4-20	5/16
010256S015	256	5/32	010440S162	440	1 5/8	010832S075	832	3/4	012520S037	1/4-20	3/8
010256S018	256	3/16	010440S175	440	1 3/4	010832S087	832	7/8	012520S050	1/4-20	1/2
010256S025	256	1/4	010448S025	448	1/4	010832S100	832	1	012520S062	1/4-20	5/8
010256S028	256	9/32	010632S009	632	3/32	010832S112	832	1 1/8	012520S075	1/4-20	3/4
010256S031	256	5/16	010632S012	632	1/8	010832S125	832	1 1/4	012520S087	1/4-20	7/8
010256S037	256	3/8	010632S015	632	5/32	010832S137	832	1 3/8	012520S100	1/4-20	1
010256S043	256	7/16	010632S018	632	3/16	010832S150	832	1 1/2	012520S125	1/4-20	1 1/4
010256S050	256	1/2	010632S025	632	1/4	010832S175	832	1 3/4	012520S150	1/4-20	1 1/2
010256S056	256	9/16	010632S031	632	5/16	010832S187	832	1 7/8	012520S175	1/4-20	1 3/4
010256S062	256	5/8	010632S037	632	3/8	010832S200	832	2	012520S200	1/4-20	2
010256S075	256	3/4	010632S043	632	7/16	011024S012	1024	1/8	012520S250	1/4-20	2 1/2
010256S087	256	7/8	010632S050	632	1/2	011024S018	1024	3/16	012528S018	1/4-28	3/16
010256S100	256	1	010632S056	632	9/16	011024S025	1024	1/4	012528S025	1/4-28	1/4
010256S112	256	1 1/8	010632S062	632	5/8	011024S031	1024	5/16	012528S037	1/4-28	3/8
010264S018	264	3/16	010632S068	632	11/16	011024S037	1024	3/8	012528S062	1/4-28	5/8
010264S037	264	3/8	010632S075	632	3/4	011024S050	1024	1/2	012528S075	1/4-28	3/4
010436B050	436	1/2	010632S087	632	7/8	011024S062	1024	5/8	012528S100	1/4-28	1
010440S009	440	3/32	010632S100	632	1	011024S075	1024	3/4	0137524S031*	3/8-24	5/16
010440S012	440	1/8	010632S112	632	1 1/8	011024S100	1024	1	0131224S081	5/16-24	13/16
010440S014	440	9/64	010632S125	632	1 1/4	011024S125	1024	1 1/4	*SLOT IS IN THREADS		
010440S015	440	5/32	010632S150	632	1 1/2	011024S150	1024	1 1/2			
010440S018	440	3/16	010632S162	632	1 5/8	011032S012	1032	1/8			
010440S025	440	1/4	010632S175	632	1 3/4	011032S018	1032	3/16			
010440S028	440	9/32	010632S187	632	1 7/8	011032S025	1032	1/4			
010440S031	440	5/16	010632S200	632	2	011032S031	1032	5/16			
010440S038	440	3/8	016932S255	632	2 1/4	011032S037	1032	3/8			
010440S043	440	7/16	010640S025	640	1/4	011032S050	1032	1/2			
010440S050	440	1/2	010640S037	640	3/8	011032S062	1032	5/8			
010440S056	440	9/16	010640S075	640	3/4	011032S075	1032	3/4			
010440S062	440	5/8	010640S100	640	1	011032S081	1032	13/16			
010440S068	440	11/16	010832S012	832	1/8	011032S087	1032	7/8			
010440S075	440	3/4	010832S018	832	3/16	011032S100	1032	1			
010440S087	440	7/8	010832S025	832	1/4	011032S106	1032	1 1/16			
010440S100	440	1	010832S028	832	9/32	011032S125	1032	1 1/4			
010440S112	440	1 1/8	010832S031	832	5/16	011032S150	1032	1 1/2			
010440S118	440	1 3/16	010832S037	832	3/8	011032S175	1032	1 3/4			





# SCREWS, BOLTS, AND THREADED ROD

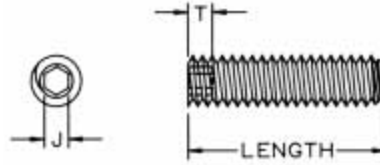

## SOCKET SET

## HEADSTYLE

THREAD SIZE	J	T	THREAD SIZE	J	T
4	.050	.070	5/16	.156	.156
6	.062	.080	3/8	.188	.188
8	.078	.090	1/2	.250	.250
10	.094	.100	5/8	.312	.312
1/4	.125	.125	3/4	.370	.185

Nominal Screw Length, in.	Tolerance on Length
Up to 0.63, incl	+/- 0.01
Over 0.63 to 2.00, incl	+/- 0.02
Over 2.00 to 6.00, incl	+/- 0.03
Over 6.00	+/- 0.06

PART NUMBER	THREAD	LENGTH	PART NUMBER	THREAD	LENGTH	PART NUMBER	THREAD	LENGTH	PART NUMBER	THREAD	LENGTH
010436T050	436	1/2	010632T087	632	7/8	011024T062	1024	5/8	012528T075	1/4-28	3/4
010440T009	440	3/32	010632T100	632	1	011024T075	1024	3/4	012528T100	1/4-28	1
010440T012	440	1/8	010632T112	632	1 1/8	011024T100	1024	1	0131218T050	5/16-18	1/2
010440T014	440	9/64	010632T125	632	1 1/4	011024T125	1024	1 1/4	0131218T075	5/16-18	3/4
010440T015	440	5/32	010632T150	632	1 1/2	011024T150	1024	1 1/2	0131218T100	5/16-18	1
010440T018	440	3/16	010632T162	632	1 5/8	011032T012	1032	1/8	0137516T050	3/8-16	1/2
010440T025	440	1/4	010632T175	632	1 3/4	011032T018	1032	3/16	0137516T075	3/8-16	3/4
010440T028	440	9/32	010632T187	632	1 7/8	011032T025	1032	1/4	0137516T100	3/8-16	1
010440T031	440	5/16	010632T200	632	2	011032T031	1032	5/16	0150013T050	1/2-13	1/2
010440T037	440	3/8	010632T225	632	2 1/4	011032T037	1032	3/8	0150013T075	1/2-13	3/4
010440T043	440	7/16	010640T025	640	1/4	011032T043	1032	7/16	0150013T100	1/2-13	1
010440T050	440	1/2	010640T037	640	3/8	011032T050	1032	1/2	0150013T125	1/2-13	1 1/4
010440T056	440	9/16	010640T075	640	3/4	011032T062	1032	5/8	0162511T050	5/8-11	1/2
010440T062	440	5/8	010640T100	640	1	011032T075	1032	3/4	0162511T075	5/8-11	3/4
010440T068	440	11/16	010832T012	832	1/8	011032T081	1032	13/16	0162511T100	5/8-11	1
010440T075	440	3/4	010832T018	832	3/16	011032T087	1032	7/8	0162511T150	5/8-11	1 1/2
010440T087	440	7/8	010832T025	832	1/4	011032T100	1032	1	0175010T025	3/4-10	1/4
010440T100	440	1	010832T028	832	9/32	011032T106	1032	1 1/16			
010440T112	440	1 1/8	010832T031	832	5/16	011032T125	1032	1 1/4			
010440T118	440	1 3/16	010832T037	832	3/8	011032T150	1032	1 1/2			
010440T125	440	1 1/4	010832T043	832	7/16	011032T175	1032	1 3/4			
010440T137	440	1 3/8	010832T050	832	1/2	011032T200	1032	2			
010440T150	440	1 1/2	010832T062	832	5/8	012520T025	1/4-20	1/4			
010440T162	440	1 5/8	010832T075	832	3/4	012520T031	1/4-20	5/16			
010440T175	440	1 3/4	010832T087	832	7/8	012520T037	1/4-20	3/8			
010448T025	448	1/4	010832T100	832	1	012520T050	1/4-20	1/2			
010632T009	632	3/32	010832T112	832	1 1/8	012520T062	1/4-20	5/8			
010632T012	632	1/8	010832T125	832	1 1/4	012520T075	1/4-20	3/4			
010632T015	632	5/32	010832T137	832	1 3/8	012520T087	1/4-20	7/8			
010632T018	632	3/16	010832T150	832	1/2	012520T100	1/4-20	1			
010632T025	632	1/4	010832T175	832	1 3/4	012520T125	1/4-20	1 1/4			
010632T031	632	5/16	010832T187	832	1 7/8	012520T150	1/4-20	1 1/2			
010632T037	632	3/8	010832T200	832	2	012520T175	1/4-20	1 3/4			
010632T043	632	7/16	011024T012	1024	1/8	012520T200	1/4-20	2			
010632T050	632	1/2	011024T018	1024	3/16	012520T250	1/4-20	2 1/2			
010632T056	632	9/16	011024T025	1024	1/4	012528T018	1/4-28	3/16			
010632T062	632	5/8	011024T031	1024	5/16	012528T025	1/4-28	1/4			
010632T068	632	11/16	011024T037	1024	3/8	012528T037	1/4-28	3/8			
010632T075	632	3/4	011024T050	1024	1/2	012528T062	1/4-28	5/8			

Due to the small head style, the longer lengths offered may not support the normal torque required for a Set Screw.

We recommend that you test samples prior to production purchases.

NOTE: LONG SLOTTED SET SCREWS  
256-632 OVER 1/2"  
832-1/4-20 OVER 3/4"



# SCREWS, BOLTS, AND THREADED ROD

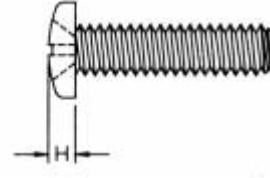

## PHILLIPS PAN

### HEADSTYLE

THREAD SIZE	A	H
2	.155 - .167	.053 - .062
4	.205 - .219	.070 - .080
6	.256 - .270	.087 - .097
8	.306 - .322	.105 - .115
10	.357 - .373	.122 - .133
12	.407 - .425	.139 - .151
1/4	.473 - .492	.162 - .175

Nominal Screw Size	0000 thru 00	0 thru 12	1/4 thru 3/4
Nominal Screw Length	Tolerance on Length		
Up to 1/2 in., incl	-0.01	-0.02	-0.03
Over 1/2 in., incl	-0.02	-0.03	-0.03
Over 1 to 2 in., incl	-	-0.06	-0.06
Over 2 in.	-	-0.09	-0.09

PART NUMBER	THREAD	LENGTH	PART NUMBER	THREAD	LENGTH	PART NUMBER	THREAD	LENGTH	PART NUMBER	THREAD	LENGTH
010256W006	256	1/16	010440W125	440	1 1/4	010832W037	832	3/8	011032W150	1032	1 1/2
010256W009	256	3/32	010440W137	440	1 3/8	010832W043	832	7/16	011032W175	1032	1 3/4
010256W012	256	1/8	010440W150	440	1 1/2	010832W050	832	1/2	011032W200	1032	2
010256W015	256	5/32	010440W162	440	1 5/8	010832W062	832	5/8			
010256W018	256	3/16	010440W175	440	1 3/4	010832W075	832	3/4			
010256W025	256	1/4	010448W015	448	5/32	010832W087	832	7/8			
010256W028	256	9/32	010448W025	448	1/4	010832W100	832	1			
010256W031	256	5/16	010448W031	448	5/16	010832W112	832	1 1/8			
010256W037	256	3/8	010632W009	632	3/32	010832W125	832	1 1/4			
010256W039	256	25/64	010632W012	632	1/8	010832W137	832	1 3/8			
010256W043	256	7/16	010632W015	632	5/32	010832W150	832	1 1/2			
010256W050	256	1/2	010632W018	632	3/16	010832W175	832	1 3/4			
010256W056	256	9/16	010632W025	632	1/4	010832W187	832	1 7/8			
010256W062	256	5/8	010632W031	632	5/16	010832W200	832	2			
010256W075	256	3/4	010632W037	632	3/8	011024W012	1024	1/8			
010256W087	256	7/8	010632W043	632	7/16	011024W018	1024	3/16			
010256W100	256	1	010632W050	632	1/2	011024W025	1024	1/4			
010256W112	256	1 1/8	010632W056	632	9/16	011024W031	1024	5/16			
010264W018	264	3/16	010632W062	632	5/8	011024W037	1024	3/8			
010264W037	264	3/8	010632W068	632	11/16	011024W050	1024	1/2			
010436W050	436	1/2	010632W075	632	3/4	011024W062	1024	5/8			
010440W009	440	3/32	010632W087	632	7/8	011024W075	1024	3/4			
010440W012	440	1/8	010632W100	632	1	011024W100	1024	1			
010440W014	440	9/64	010632W112	632	1 1/8	011024W125	1024	1 1/4			
010440W018	440	3/16	010632W125	632	1 1/4	011024W150	1024	1 1/2			
010440W025	440	1/4	010632W150	632	1 1/2	011032W012	1032	1/8			
010440W028	440	9/32	010632W162	632	1 5/8	011032W018	1032	3/16			
010440W031	440	5/16	010632W175	632	1 3/4	011032W025	1032	1/4			
010440W037	440	3/8	010632W187	632	1 7/8	011032W031	1032	5/16			
010440W043	440	7/16	010632W200	632	2	011032W037	1032	3/8			
010440W050	440	1/2	010640W025	640	1/4	011032W043	1032	7/16			
010440W056	440	9/16	010640W037	640	3/8	011032W050	1032	1/2			
010440W062	440	5/8	010640W075	640	3/4	011032W062	1032	5/8			
010440W068	440	11/16	010640W100	640	1	011032W075	1032	3/4			
010440W075	440	3/4	010832W012	832	1/8	011032W081	1032	13/16			
010440W087	440	7/8	010832W018	832	3/16	011032W087	1032	7/8			
010440W100	440	1	010832W025	832	1/4	011032W100	1032	1			
010440W112	440	1 1/8	010832W028	832	9/32	011032W106	1032	1 1/16			
010440W118	440	1 3/16	010832W031	832	5/16	011032W125	1032	1 1/4			



# SCREWS, BOLTS, AND THREADED ROD

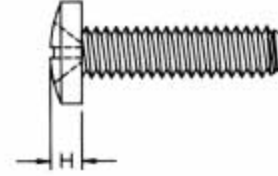

## PHILLIPS BINDER

### HEADSTYLE

THREAD SIZE	A	H
2	.171 - .181	.043 - .050
4	.223 - .235	.061 - .068
6	.275 - .290	.078 - .087
8	.326 - .344	.095 - .105
10	.378 - .399	.112 - .123
12	.430 - .454	.130 - .141
1/4	.498 - .525	.152 - .165

Nominal Screw Size	0000 thru 00	0 thru 12	1/4 thru 3/4
	Tolerance on Length		
Up to 1/2 in., incl	-0.01	-0.02	-0.03
Over 1/2 TO 1 in., incl	-0.02	-0.03	-0.03
Over 1 to 2 in., incl	-	-0.06	-0.06
Over 2 in.	-	-0.09	-0.09

PART NUMBER	THREAD	LENGTH	PART NUMBER	THREAD	LENGTH	PART NUMBER	THREAD	LENGTH
010436WB050	436	1/2	010832WB125	832	1 1/4	012520WB075	1/4-20	3/4
010440WB009	440	3/32	010832WB137	832	1 3/8	012520WB087	1/4-20	7/8
010440WB012	440	1/8	010832WB150	832	1 1/2	012520WB100	1/4-20	1
010440WB014	440	9/64	010832WB175	832	1 3/4	012520WB125	1/4-20	1 1/4
010440WB018	440	3/16	010832WB187	832	1 7/8	012520WB150	1/4-20	1 1/2
010440WB025	440	1/4	010832WB200	832	2	012520WB175	1/4-20	1 3/4
010440WB028	440	9/32	011024WB012	1024	1/8	012520WB200	1/4-20	2
010440WB031	440	5/16	011024WB018	1024	3/16	012520WB250	1/4-20	2 1/2
010440WB037	440	3/8	011024WB025	1024	1/4	012528WB018	1/4-28	3/16
010440WB043	440	7/16	011024WB031	1024	5/16	012528WB037	1/4-28	3/8
010440WB050	440	1/2	011024WB037	1024	3/8	012528WB062	1/4-28	5/8
010440WB056	440	9/16	011024WB050	1024	1/2	012528WB075	1/4-28	3/4
010440WB062	440	5/8	011024WB062	1024	5/8	012528WB100	1/4-28	1
010440WB068	440	11/16	011024WB075	1024	3/4			
010440WB075	440	3/4	011024WB100	1024	1			
010440WB087	440	7/8	011024WB125	1024	1 1/4			
010440WB100	440	1	011024WB150	1024	1 1/2			
010440WB112	440	1 1/8	011032WB012	1032	1/8			
010440WB118	440	1 3/16	011032WB018	1032	3/16			
010440WB125	440	1 1/4	011032WB025	1032	1/4			
010440WB137	440	1 3/8	011032WB031	1032	5/16			
010440WB150	440	1 1/2	011032WB037	1032	3/8			
010440WB162	440	1 5/8	011032WB043	1032	7/16			
010440WB175	440	1 3/4	011032WB050	1032	1/2			
010448WB015	448	5/32	011032WB062	1032	5/8			
010448WB025	448	1/4	011032WB075	1032	3/4			
010832WB012	832	1/8	011032WB081	1032	13/16			
010832WB018	832	3/16	011032WB087	1032	7/8			
010832WB025	832	1/4	011032WB100	1032	1			
010832WB028	832	9/32	011032WB106	1032	1/16			
010832WB031	832	5/16	011032WB125	1032	1/4			
010832WB037	832	3/8	011032WB150	1032	1 1/2			
010832WB043	832	7/16	011032WB175	1032	1 3/4			
010832WB050	832	1/2	011032WB200	1032	2			
010832WB062	832	5/8	012520WB025	1/4-20	1/4			
010832WB075	832	3/4	012520WB031	1/4-20	5/16			
010832WB087	832	7/8	012520WB037	1/4-20	3/8			
010832WB100	832	1	012520WB050	1/4-20	1/2			
010832WB112	832	1 1/8	012520WB062	1/4-20	5/8			



# SCREWS, BOLTS, AND THREADED ROD

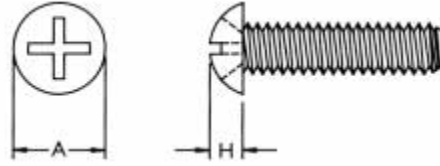

THREAD SIZE	A	H
1	.122-.138	.051-.061
2	.146-.162	.059-.069
3	.169-.187	.067-.078
4	.193-.211	.075-.086
6	.240-.260	.091-.103
8	.287-.309	.107-.120
10	.334-.359	.123-.137
12	.382-.408	.139-.153
1/4	.443-.472	.160-.175

Nominal Screw Size	0000 thru 00	0 thru 12	1/4 thru 3/4
Nominal Screw Length	Tolerance on Length		
Up to 1/2 in., incl	-0.01	-0.02	-0.03
Over 1/2 to 1 in., incl	-0.02	-0.03	-0.03
Over 1 to 2 in., incl	-	-0.06	-0.06
Over 2 in.	-	-0.09	-0.06

## PHILLIPS ROUND

### HEADSTYLE

PART NUMBER	THREAD	LENGTH	PART NUMBER	THREAD	LENGTH	PART NUMBER	THREAD	LENGTH	PART NUMBER	THREAD	LENGTH
010632WR009	632	3/32	010632WR068	632	11/16	010632WR225	632	2 1/4	011024WR062	1024	5/8
010632WR012	632	1/8	010632WR075	632	3/4	010640WR025	640	1/4	011024WR075	1024	3/4
010632WR015	632	5/32	010632WR087	632	7/8	010640WR037	640	3/8	011024WR100	1024	1
010632WR018	632	3/16	010632WR100	632	1	010640WR075	640	3/4	011024WR125	1024	1 1/4
010632WR025	632	1/4	010632WR112	632	1 1/8	010640WR100	640	1	011024WR150	1024	1 1/2
010632WR031	632	5/16	010632WR125	632	1 1/4	011024WR012	1024	1/8	011032WR012	1032	1/8
010632WR037	632	3/8	010632WR150	632	1 1/2	011024WR018	1024	3/16	011032WR018	1032	3/16
010632WR043	632	7/16	010632WR162	632	1 5/8	011024WR02	1024	1/4	011032WR025	1032	1/4
010632WR050	632	1/2	010632WR175	632	1 3/4	011024WR031	1024	5/16	011032WR031	1032	5/16
010632WR056	632	9/16	010632WR187	632	1 7/8	011024WR037	1024	3/8	011032WR037	1032	3/8
010632WR062	632	5/8	010632WR200	632	2	011024WR050	1024	1/2	011032WR043	1032	7/16



**ITEM NUMBER - 04AS0750MSN**  
**Machine Screw and Nut Assortment**

**ITEM NUMBER - 04AS0305MCS**  
**Metal Core Screw Assortment**



# SCREWS, BOLTS, AND THREADED ROD

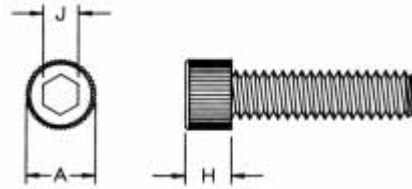

## HEX SOCKET CAP

THREAD SIZE	A	H	J	Key Engagement Min.
2	.134-.140	.083-.086	5/64"	.038
4	.176-.183	.108-.112	3/32"	.051
6	.218-.226	.134-.138	7/64"	.064
8	.262-.270	.159-.164	9/64"	.077
10	.303-.312	.185-.190	5/32"	.090
1/4	.365-.375	.244-.250	3/16"	.120
5/16	.457-.469	.306-.312	1/4"	.151
3/8	.550-.562	.368-.375	5/16"	.182
1/2	.735-.750	.492-.500	3/8"	.245
5/8	.921-.938	.616-.625	1/2"	.307

Nominal Screw Size	0 thru 3/8	7/16 thru 3/4	7/8 thru 1 1/2	Over 1 1/2
	incl	incl	incl	
Nominal Screw Length, in		Tolerance on Length		
Up to 1.00, incl	-0.03	-0.03	-0.05	. . .
Over 1.00 to 2.50, incl	-0.04	-0.06	-0.10	-0.18
Over 2.50 to 6.00, incl	-0.06	-0.08	-0.14	-0.20
Over 6.00	-0.12	-0.12	-0.20	-0.24

PART NUMBER	THREAD	LENGTH	PART NUMBER	THREAD	LENGTH	PART NUMBER	THREAD	LENGTH	PART NUMBER	THREAD	LENGTH
3404360050	436	1/2	3406320187	632	1 7/8	3410320037	1032	3/8	3431218300	5/16-18	3 *
3404400009	440	3/32	3406320225	632	2 1/4	3410320050	1032	1/2	3437516050	3/8-16	1/2
3404400012	440	1/8	3406400025	640	1/4	3410320062	1032	5/8	3437516075	3/8-16	3/4
3404400014	440	9/64	3406400037	640	3/8	3410320075	1032	3/4	3437516100	3/8-16	1
3404400018	440	3/16	3406400075	640	3/4	3410320081	1032	13/16	3437516125	3/8-16	1 1/4 *
3404400025	440	1/4	3406400100	640	1	3410320087	1032	7/8	3437516150	3/8-16	1 1/2 *
3404400028	440	9/32	3408320012	832	1/8	3410320010	1032	1	3437516200	3/8-16	2 *
3404400031	440	5/16	3408320018	832	3/16	3410320106	1032	1 1/16	3437516250	3/8-16	2 1/2 *
3404400037	440	3/8	3408320028	832	9/32	3410320125	1032	1 1/4	3437516300	3/8-16	3 *
3404400043	440	7/16	3408320025	832	1/4	3410320150	1032	1 1/2	3450013050	1/2-13	1/2
3404400050	440	1/2	3408320031	832	5/16	3410320200	1032	2	3450013075	1/2-13	3/4
3404400056	440	9/16	3408320037	832	3/8	3425200018	1/4-20	3/16	3450013100	1/2-13	1
3404400062	440	5/8	3408320043	832	7/16	3425200031	1/4-20	5/16	3450013125	1/2-13	1 1/4 *
3404400068	440	11/16	3408320050	832	1/2	3425200037	1/4-20	3/8	3450013150	1/2-13	1 1/2 *
3404400075	440	3/4	3408320062	832	5/8	3425200050	1/4-20	1/2	3450013200	1/2-13	2 *
3404400087	440	7/8	3408320075	832	3/4	3425200062	1/4-20	5/8	3450013250	1/2-13	2 1/2 *
3404400100	440	1	3408320087	832	7/8	3425200075	1/4-20	3/4	3450013300	1/2-13	3 *
3404400112	440	1 1/8	3408320100	832	1	3425200087	1/4-20	7/8	3462511050	5/8-11	1/2
3404400125	440	1 1/4	3408320112	832	1 1/8	3425200100	1/4-20	1	3462511075	5/8-11	3/4
3404400137	440	1 3/8	3408320125	832	1 1/4	3425200125	1/4-20	1 1/4	3462511100	5/8-11	1
3404400150	440	1 1/2	3408320137	832	1 3/8	3425200150	1/4-20	1 1/2	3462511150	5/8-11	1 1/2
3406320009	632	3/32	3408320150	832	1 1/2	3425200175	1/4-20	1 3/4	3462511200	5/8-11	2
3406320012	632	1/8	3408320175	832	1 3/4	3425200200	1/4-20	2	3462511250	5/8-11	2 1/2
3406320015	632	5/32	3408320200	832	2	3425200225	1/4-20	2 1/4 *	3462511300	5/8-11	3
3406320018	632	3/16	3410240012	1024	1/8	3425200250	1/4-20	2 1/2 *	*NOT FULL THREAD		
3406320025	632	1/4	3410240018	1024	3/16	3425200250FT	1/4-20	2 1/2			
3406320031	632	5/16	3410240025	1024	1/4	3425280018	1/4-28	3/16			
3406320037	632	3/8	3410240031	1024	5/16	3425280025	1/4-28	1/4			
3406320043	632	7/16	3410240037	1024	3/8	3425280037	1/4-28	3/8			
3406320050	632	1/2	3410240050	1024	1/2	3425280075	1/4-28	3/4			
3406320062	632	5/8	3410240062	1024	5/8	3425280100	1/4-28	1			
3406320068	632	11/16	3410240075	1024	3/4	3425280150	1/4-28	1			
3406320075	632	3/4	3410240100	1024	1	3431218050	5/16-18	1/2			
3406320087	632	7/8	3410240125	1024	1 1/4	3431218075	5/16-18	3/4			
3406320100	632	1	3410240150	1024	1 1/2	3431218100	5/16-18	1			
3406320112	632	1 1/8	3410320012	1032	1/8	3431218125	5/16-18	1 1/4 *			
3406320125	632	1 1/4	3410320018	1032	3/16	3431218150	5/16-18	1 1/2 *			
3406320150	632	1 1/2	3410320025	1032	1/4	3431218200	5/16-18	2 *			
3406320175	632	1 3/4	3410320031	1032	5/16	3431218250	5/16-18	2 1/2 *			



# SCREWS, BOLTS, AND THREADED ROD

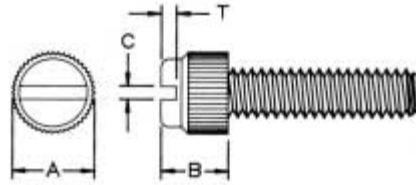

THREAD SIZE	A	H	J	T
4	.317	.216	.039	.045
6	.336	.243	.035	.051
8	.381	.280	.049	.040
10	.395	.305	.040	.060
1/4	.480	.305	.045	.060

Nominal Screw Length	Tolerance on Length
Up to 1 including	+/-0.03
Over 1 to 2 including	+/-0.06
Over 2	+/-0.09

## ECONOMY GRADE

## THUMB SCREWS

PART NUMBER	THREAD	LENGTH	PART NUMBER	THREAD	LENGTH	PART NUMBER	THREAD	LENGTH	PART NUMBER	THREAD	LENGTH
090440009TEG	440	3/32	090632125TEG	632	1 1/4	091024150TEG	1024	1 1/2	092520025TEG	1/4-20	1/4
090440012TEG	440	1/8	090632150TEG	632	1 1/2	091032012TEG	1032	1/8	092520031TEG	1/4-20	5/16
090440014TEG	440	9/64	090632162TEG	632	1 5/8	091032018TEG	1032	3/16	092520037TEG	1/4-20	3/8
090440018TEG	440	3/16	090632175TEG	632	1 3/4	091032025TEG	1032	1/4	092520050TEG	1/4-20	1/2
090440025TEG	440	1/4	090632187TEG	632	1 7/8	091032031TEG	1032	5/16	092520062TEG	1/4-20	5/8
090440028TEG	440	9/32	090632225TEG	632	2 1/4	091032037TEG	1032	3/8	092520075TEG	1/4-20	3/4
090440031TEG	440	5/16	090640025TEG	640	1/4	091032043TEG	1032	7/16	092520087TEG	1/4-20	7/8
090440037TEG	440	3/8	090640037TEG	640	3/8	091032050TEG	1032	1/2	092520100TEG	1/4-20	1
090440043TEG	440	7/16	090640075TEG	640	3/4	091032062TEG	1032	5/8	092520125TEG	1/4-20	1 1/4
090440050TEG	440	1/2	090640100TEG	640	1	091032075TEG	1032	3/4	092520150TEG	1/4-20	1 1/2
090440056TEG	440	9/16	090832012TEG	832	1/8	091032081TEG	1032	13/16	092520175TEG	1/4-20	1 3/4
090440062TEG	440	5/8	090832018TEG	832	3/16	091032087TEG	1032	7/8	092520200TEG	1/4-20	2
090440068TEG	440	11/16	090832025TEG	832	1/4	091032100TEG	1032	1	092520250TEG	1/4-20	2 1/2
090440075TEG	440	3/4	090832028TEG	832	9/32	091032106TEG	1032	1 1/16	092528018TEG	1/4-28	3/16
090440087TEG	440	7/8	090832031TEG	832	5/16	091032106TEG	1032	1 1/4	092528025TEG	1/4-28	1/4
090440100TEG	440	1	090832037TEG	832	3/8	091032125TEG	1032	1 1/4	092528037TEG	1/4-28	3/8
090440112TEG	440	1 1/8	090832043TEG	832	7/16	091032150TEG	1032	1 1/2	092528050TEG	1/4-28	1/2
090440118TEG	440	1 3/16	090832050TEG	832	1/2	091032175TEG	1032	1 3/4	092528075TEG	1/4-28	3/4
090440125TEG	440	1 1/4	090832062TEG	832	5/8	091032200TEG	1032	2	092528100TEG	1/4-28	1
090440137TEG	440	1 3/8	090832075TEG	832	3/4						
090440150TEG	440	1 1/2	090832087TEG	832	7/8						
090440175TEG	440	1 3/4	090832100TEG	832	1						
090448025TEG	448	1/4	090832112TEG	832	1 1/8						
090632009TEG	632	3/32	090832125TEG	832	1 1/4						
090632012TEG	632	1/8	090832137TEG	832	1 3/8						
090632015TEG	632	5/32	090832150TEG	832	1 1/2						
090632018TEG	632	3/16	090832175TEG	832	1 3/4						
090632025TEG	632	1/4	090832187TEG	832	1 7/8						
090632031TEG	632	5/16	090832200TEG	832	2						
090632037TEG	632	3/8	091024012TEG	1024	1/8						
090632043TEG	632	7/16	091024018TEG	1024	3/16						
090632050TEG	632	1/2	091024025TEG	1024	1/4						
090632056TEG	632	9/16	091024031TEG	1024	5/16						
090632062TEG	632	5/8	091024037TEG	1024	3/8						
090632068TEG	632	11/16	091024050TEG	1024	1/2						
090632075TEG	632	3/4	091024062TEG	1024	5/8						
090632087TEG	632	7/8	091024075TEG	1024	3/4						
090632100TEG	632	1	091024100TEG	1024	1						
090632112TEG	632	1 1/8	091024125TEG	1024	1 1/4						



# SCREWS, BOLTS, AND THREADED ROD

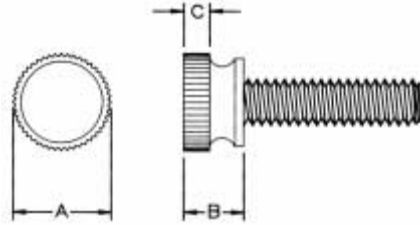

## KNURLED HEAD THUMB SCREWS

PART NUMBER	THREAD	LENGTH
090440018T	440	3/16 (4,57)
090440025T	440	1/4 (6,35)
090440037T	440	3/8 (9,53)
090440050T	440	1/2 (12,70)
090440075T	440	3/4 (19,05)
090632025T	632	1/4 (6,35)
090632037T	632	3/8 (9,53)
090632050T	632	1/2 (12,70)
090632075T	632	3/4 (19,05)
090632100T	632	1 (25,40)
090832018T	832	3/16 (4,76)
090832037T	832	3/8 (9,53)
090832050T	832	1/2 (12,70)
090832075T	832	3/4 (19,05)
090832100T	832	1 (25,40)
091024050T	1024	1/2 (12,70)
091024075T	1024	3/4(19,05)
091024100T	1024	1(25,40)
091024125T	1024	1 1/4(31,75)
091024200T	1024	2 (50,80)
091032037T	1032	3/8 (9,53)
091032050T	1032	1/2 (12,70)
091032075T	1032	3/4 (19,05)
091032100T	1032	1 (25,40)
091032106T	1032	1 1/16(26,99)
091032150T	1032	1 1/2(38,10)
091032200T	1032	2 (50,80)
092520050T	1/4-20	1/2 (12,70)
092520075T	1/4-20	3/4 (19,05)
092520100T	1/4-20	1 (25,40)
092520125T	1/4-20	1 1/4(31,75)
092520150T	1/4-20	1 1/2(38,10)
0931218050T	5/16-18	1/2 (12,70)
0931218100T	5/16-18	1 (25,40)
0931218150T	5/16-18	1 1/2(38,10)
0931218200T	5/16-18	2 (50,80)
0937516050T	3/8-16	1/2 (12,70)
0937516100T	3/8-16	1 (25,40)
0937516150T	3/8-16	1 1/2(38,10)
0937516200T	3/8-16	2 (50,80)
0950013050T	1/2-13	1/2 (12,70)
0950013100T	1/2-13	1 (25,40)
0950013150T	1/2-13	1 1/2(38,10)
0950013200T	1/2-13	2 (50,80)

THREAD SIZE	A *	B *	C
4	.300 (7,62)	.280 (7,11)	.125 (3,17)
6	.360 (9,14)	.275 (6,99)	.125 (3,18)
8	.425 (10,80)	.305 (7,75)	.140 (3,56)
10	.425 (10,80)	.325 (8,26)	.140 (3,56)
1/4	.540 (13,72)	.365 (9,27)	.155 (3,94)
5/16	.615 (15,62)	.385 (9,78)	.171 (4,34)
3/8	.687 (17,45)	.430 (10,92)	.187 (4,75)
1/2	.750 (19,05)	.468 (11,89)	.203 (5,16)

\* +/- .010 on A and B Dimensions

Nominal Screw Length	Tolerance on Length
Up to 1 including	+/-0.03
Over 1 to 2 including	+/-0.06
Over 2	+/-0.09

## OVAL HEAD THUMB SCREWS

PART NUMBER	THREAD	LENGTH
092502037V	1/4-20	3/8
092502050V	1/4-20	1/2
092502062V	1/4-20	5/8
092502100V	1/4-20	1
092502150V	1/4-20	1 1/2
092502175V	1/4-20	1 3/4
092502200V	1/4-20	2
092502250V	1/4-20	2 1/2

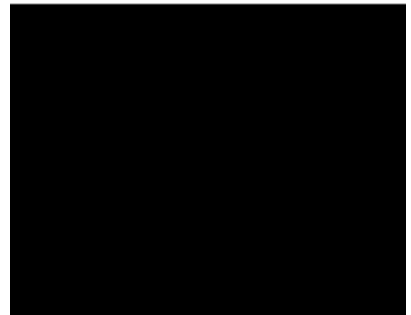

THREAD SIZE	HD WIDTH	HD HEIGHT	HD THICKNESS
1/4	.780	.550	5/32

# SCREWS, BOLTS, AND THREADED ROD

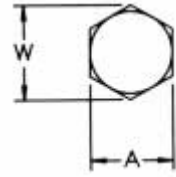
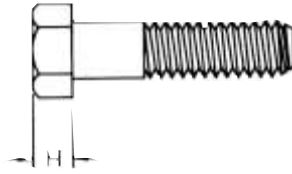

THREAD SIZE	A	W	H
1/4	.425-.438	.484-.505	.150-.188
5/16	.484-.500	.552-.577	.195-.235
3/8	.544-.562	.620-.650	.226-.268
1/2	.725-.750	.826-.866	.302-.364
5/8	.906-.938	1.033-1.083	.378-.444
3/4	1.088-1.125	1.240-1.299	.455-.524
7/8	1.269-1.312	1.447-1.516	.531-.604

Nominal Length	1/4 to 3/8	7/16 to 1/2	9/16 to 3/4	7/8 to 1	1 1/8 to 1 1/8	over 1-1/2
Up to 1 in., incl.	+0.02 -0.03	+0.02 -0.03	+0.02 -0.03	----	----	----
Over 1 in. to 2-1.2 in., incl.	+0.02 -0.04	+0.04 -0.06	+0.06 -0.08	+0.08 -0.10	+0.12 -0.12	+0.18 -0.18
Over 2-1/2 in. to 4 in., incl.	+0.04 -0.06	+0.06 -0.08	+0.08 -0.10	+0.10 -0.14	+0.16 -0.16	+0.20 -0.20
Over 4 in. to 6 in., incl.	+0.06 -0.10	+0.08 -0.10	+0.10 -0.10	+0.12 -0.16	+0.18 -0.18	+0.22 -0.22
Longer than 6 in.	+0.10 -0.18	+0.12 -0.18	+0.14 -0.18	+0.16 -0.20	+0.22 -0.22	+0.24 -0.24

## HEX CAP SCREWS

PART NUMBER	THREAD	LENGTH	PART NUMBER	THREAD	LENGTH	PART NUMBER	THREAD	LENGTH	PART NUMBER	THREAD	LENGTH
0325020037	1/4-20	3/8	0331218150	5/16-18	1 1/2	0337516400	3/8-16	4	0350013600	1/2-13	6
0325020050	1/4-20	1/2	0331218200	5/16-18	2	0337516450	3/8-16	4 1/2	0362511050	5/8-11	1/2
0325020062	1/4-20	5/8	0331218250	5/16-18	2 1/2	0337516500	3/8-16	5	0362511075	5/8-11	3/4
0325020075	1/4-20	3/4	0331218300	5/16-18	3	0337516550	3/8-16	5 1/2	0362511100	5/8-11	1
0325020100	1/4-20	1	0331218350	5/16-18	3 1/2	0337516600	3/8-16	6	0362511150	5/8-11	1 1/2
0325020125	1/4-20	1 1/4	0331218400	5/16-18	4	0337524050	3/8-24	1/2	0362511200	5/8-11	2
0325020150	1/4-20	1 1/2	0331218450	5/16-18	4 1/2	0350013050	1/2-13	1/2	0362511250	5/8-11	2 1/2
0325020200	1/4-20	2	0331218500	5/16-18	5	0350013075	1/2-13	3/4	0362511300	5/8-11	3
0325020250	1/4-20	2 1/2	0331218550	5/16-18	5 1/2	0350013087	1/2-13	7/8	0362511350	5/8-11	3 1/2
0325020300	1/4-20	3	0331218600	5/16-18	6	0350013100	1/2-13	1	0362511400	5/8-11	4
0325020350	1/4-20	3 1/2	0331224050	5/16-24	1/2	0350013125	1/2-13	1 1/4	0362511400FT	5/8-11	4
0325020400	1/4-20	4	0337516050	3/8-16	1/2	0350013150	1/2-13	1 1/2	0362511450	5/8-11	4 1/2
0325020450	1/4-20	4 1/2	0337516075	3/8-16	3/4	0350013175	1/2-13	1 3/4	0362511500	5/8-11	5
0325020500	1/4-20	5	0337516100	3/8-16	1	0350013200	1/2-13	2	0362511550	5/8-11	5 1/2
0325020550	1/4-20	5 1/2	0337516125	3/8-16	1 1/4	0350013250	1/2-13	2 1/2	0362511600	5/8-11	6
0325020600	1/4-20	6	0337516150	3/8-16	1 1/2	0350013300	1/2-13	3	0375010075	3/4-10	3/4
0331218050	5/16-18	1/2	0337516200	3/8-16	2	0350013350	1/2-13	3 1/2	0375010400FT	3/4-10	4
0331218075	5/16-18	3/4	0337516200FT	3/8-16	2	0350013400	1/2-13	4	0375010550	3/4-10	5 1/2
0331218100	5/16-18	1	0337516250	3/8-16	2 1/2	0350013450	1/2-13	4 1/2	0387509075	7/8-9	3/4
0331218125	5/16-18	1 1/4	0337516300	3/8-16	3	0350013500	1/2-13	5	0387509450FT	7/8-9	4 1/2
0331218137	5/16-18	1 3/8	0337516350	3/8-16	3 1/2	0350013550	1/2-13	5 1/2			

ALL PARTS UP TO 1" LONG ARE FULLY THREADED

## "SPECIAL ITEM" SLOTTED HEX WASHER CAP

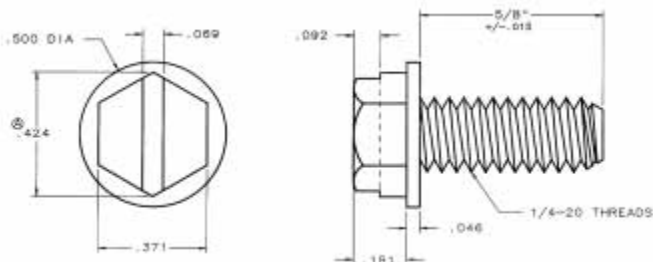

ITEM NUMBER	-----	DESCRIPTION	-----
401017	1/4-20 3/8	Slotted Hex Washer Cap	
401016	1/4-20 5/8	Slotted Hex Washer Cap	



# SCREWS, BOLTS, AND THREADED ROD

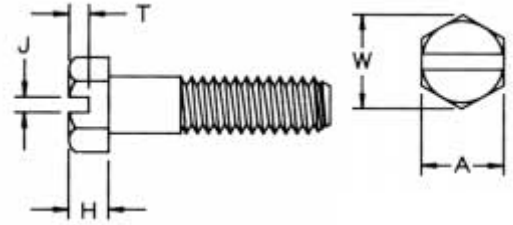

THREAD SIZE	A	W	H	J	T
1/4	.425-.438	.484-.505	.150-.188	.070	.090
5/16	.484-.500	.552-.577	.195-.235	.080	.110
3/8	.544-.562	.620-.650	.226-.268	.090	.140
1/2	.725-.750	.826-.866	.302-.364	.100	.160
5/8	.906-.938	1.033-1.083	.378-.444	.110	.170

Nominal Length	1/4 to 3/8	7/16 to 1/2	9/16 to 3/4	7/8 to 1	1 1/8 to 1 1/8	over 1-1/2
Up to 1 in., incl.	+0.02 -0.03	+0.02 -0.03	+0.02 -0.03	----	----	----
Over 1 in. to 2-1.2 in., incl.	+0.02 -0.04	+0.04 -0.06	+0.06 -0.08	+0.08 -0.10	+0.12 -0.16	+0.18 -0.18
Over 2-1/2 in. to 4 in., incl.	+0.04 -0.06	+0.06 -0.08	+0.08 -0.10	+0.10 -0.14	+0.16 -0.16	+0.20 -0.20
Over 4 in. to 6 in., incl.	+0.06 -0.10	+0.08 -0.10	+0.10 -0.10	+0.12 -0.16	+0.18 -0.18	+0.22 -0.22
Longer than 6 in.	+0.10 -0.18	+0.12 -0.18	+0.14 -0.18	+0.16 -0.20	+0.22 -0.22	+0.24 -0.24

## SLOTTED HEX CAP SCREWS

PART NUMBER	THREAD	LENGTH	PART NUMBER	THREAD	LENGTH	PART NUMBER	THREAD	LENGTH	PART NUMBER	THREAD	LENGTH
3225020037	1/4-20	3/8	3231218150	5/16-18	1 1/2	3237516450	3/8-16	4 1/2	3262511075	5/8-11	3/4
3225020050	1/4-20	1/2	3231218200	5/16-18	2	3237516500	3/8-16	5	3262511100	5/8-11	1
3225020062	1/4-20	5/8	3131218250	5/16-18	2 1/2	3237516550	3/8-16	5 1/2	3262511150	5/8-11	1 1/2
3225020075	1/4-20	3/4	3231218300	5/16-18	3	3237516600	3/8-16	6	3262511200	5/8-11	2
3225020100	1/4-20	1	3231218350	5/16-18	3 1/2	3237524050	3/8-24	1/2	3262511250	5/8-11	2 1/2
3225020125	1/4-20	1 1/4	3231218400	5/16-18	4	3250013050	1/2-13	1/2	3262511300	5/8-11	3
3225020150	1/4-20	1 1/2	3231218450	5/16-18	4 1/2	3250013075	1/2-13	3/4	3262511350	5/8-11	3 1/2
3225020200	1/4-20	2	3231218500	5/16-18	5	3250013087	1/2-13	7/8	3262511400	5/8-11	4
3225020250	1/4-20	2 1/2	3231218550	5/16-18	5 1/2	3250013100	1/2-13	1	3262511400FT	5/8-11	4
3225020300	1/4-20	3	3231218600	5/16-18	6	3250013125	1/2-13	1 1/4	3262511450	5/8-11	4 1/2
3225020350	1/4-20	3 1/2	3231224050	5/16-24	1/2	3250013150	1/2-13	1 1/2	3262511500	5/8-11	5
3225020400	1/4-20	4	3237516050	3/8-16	1/2	3250013200	1/2-13	2	3262511550	5/8-11	5 1/2
3225020450	1/4-20	4 1/2	3237516075	3/8-16	3/4	3250013250	1/2-13	2 1/2	3262511600	5/8-11	6
3225020500	1/4-20	5	3237516100	3/8-16	1	3250013300	1/2-13	3			
3225020550	1/4-20	5 1/2	3237516125	3/8-16	1 1/4	3250013350	1/2-13	3 1/2			
3225020600	1/4-20	6	3237516150	3/8-16	1 1/2	3250013400	1/2-13	4			
3231218050	5/16-18	1/2	3237516200	3/8-16	2	3250013450	1/2-13	4 1/2			
3231218075	5/16-18	3/4	3237516250	3/8-16	2 1/2	3250013500	1/2-13	5			
3231218100	5/16-18	1	3237516300	3/8-16	3	3250013550	1/2-13	5 1/2			
3231218125	5/16-18	1 1/4	3237516350	3/8-16	3 1/2	3250013600	1/2-13	6			
3231218137	5/16-18	1 3/8	3237516400	3/8-16	4	3262511050	5/8-11	1/2			

ALL PARTS UP TO 1" LONG ARE FULLY THREADED

## SLOTTED HEX WASHER CAP

PART NUMBER	THREAD	LENGTH
32W37516050	3/8-16	1/2
32W37516075	3/8-16	3/4
32W37516100	3/8-16	1
32W37516125	3/8-16	1 1/4
32W37516150	3/8-16	1 1/2
32W37516200	3/8-16	2
32W37516250	3/8-16	2 1/2
32W37516300	3/8-16	3

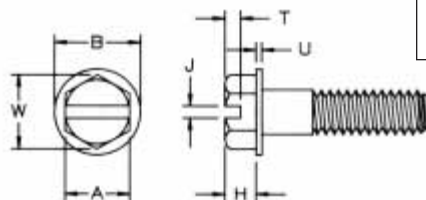

A	B	H	U	J	T	W
.557	.750	.282	.050	.087	.149	.643

# SCREWS, BOLTS, AND THREADED ROD

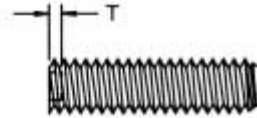
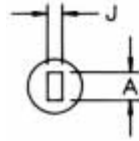

## GRUB SLOTTED HEADSTYLE

THREAD SIZE	T	A	J
6	.030	.080	.025
8	.035	.080	.028
10	.050	.130	.035
1/4	.060	.160	.040
1/2	.130	.350	.075
1	.178	.115	.516

PART NUMBER	THREAD	LENGTH	PART NUMBER	THREAD	LENGTH	PART NUMBER	THREAD	LENGTH	PART NUMBER	THREAD	LENGTH
010632G009	632	3/32	010832G100	832	1	012520G025	1/4-20	1/4	012520G250	1/4-20	2 1/2
010632G012	632	1/8	010832G112	832	1 1/8	012520G031	1/4-20	5/16	012528G018	1/4-28	3/16
010632G015	632	5/32	010832G125	832	1 1/4	012520G037	1/4-20	3/8	012528G025	1/4-28	1/4
010632G018	632	3/16	010832G137	832	1 3/8	012520G050	1/4-20	1/2	012528G037	1/4-28	3/8
010632G025	632	1/4	010832G150	832	1 1/2	012520G062	1/4-20	5/8	012528G062	1/4-28	5/8
010632G031	632	5/16	010832G175	832	1 3/4	012520G075	1/4-20	3/4	012528G075	1/4-28	3/4
010632G037	632	3/8	010832G187	832	1 7/8	012520G087	1/4-20	7/8	012528G100	1/4-28	1
010632G043	632	7/16	010832G200	832	2	012520G100	1/4-20	1	0150013G050	1/2-13	1/2
010632G050	632	1/2	011024G012	1024	1/8	012520G125	1/4-20	1 1/4	0150013G075	1/2-13	3/4
010632G056	632	9/16	011024G018	1024	3/16	012520G150	1/4-20	1 1/2	0150013G100	1/2-13	1
010632G062	632	5/8	011024G025	1024	1/4	012520G175	1/4-20	1 3/4	0110008G062	1 - 8	5/8
010632G068	632	11/16	011024G031	1024	5/16	012520G200	1/4-20	2			
010632G075	632	3/4	011024G037	1024	3/8						
010632G087	632	7/8	011024G050	1024	1/2						
010632G100	632	1	011024G062	1024	5/8						
010632G112	632	1 1/8	011024G075	1024	3/4						
010632G125	632	1 1/4	011024G100	1024	1						
010632G150	632	1 1/2	011024G125	1024	1 1/4						
010632G162	632	1 5/8	011024G150	1024	1 1/2						
010632G175	632	1 3/4	011032G012	1032	1/8						
010632G187	632	1 7/8	011032G018	1032	3/16						
010640G025	640	1/4	011032G025	1032	1/4						
010640G037	640	3/8	011032G031	1032	5/16						
010640G075	640	3/4	011032G037	1032	3/8						
010640G100	640	1	011032G043	1032	7/16						
010832G012	832	1/8	011032G050	1032	1/2						
010832G018	832	3/16	011032G062	1032	5/8						
010832G025	832	1/4	011032G075	1032	3/4						
010832G028	832	9/32	011032G081	1032	13/16						
010832G031	832	5/16	011032G087	1032	7/8						
010832G037	832	3/8	011032G100	1032	1						
010832G043	832	7/16	011032G106	1032	1 1/16						
010832G050	832	1/2	011032G125	1032	1 1/4						
010832G062	832	5/8	011032G150	1032	1 1/2						
010832G075	832	3/4	011032G175	1032	1 3/4						
010832G087	832	7/8	011032G200	1032	2						



# SCREWS, BOLTS, AND THREADED ROD

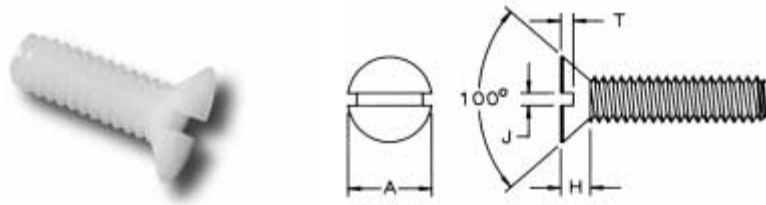

THREAD SIZE	A	* REF ONLY * H	J	T
2	.143-.172	.037	.023-.031	.012-.019
4	.193-.225	.049	.031-.039	.017-.024
6	.238-.279	.060	.039-.048	.022-.030
8	.285-.332	.072	.045-.054	.027-.036
10	.333-.385	.083	.050-.060	.031-.042
1/4	.442-.507	.110	.064-.075	.042-.055

## 100° FLAT HEADSTYLE

PART NUMBER	THREAD	LENGTH	PART NUMBER	THREAD	LENGTH	PART NUMBER	THREAD	LENGTH	PART NUMBER	THREAD	LENGTH
020256B012	256	1/8	020440B037	440	3/8	020632B050	632	1/2	021032B050	1032	1/2
020256B018	256	3/16	020440B0150	440	1/2	020632B062	632	5/8	021032B068	1032	11/16
020256B031	256	5/16	020440B053	40	17/32	020632B100	632	1	022520B037	1/4-20	3/8
020256B050	256	1/2	020440B062	440	5/8	020632B112	632	1 1/8	022520B075	1/4-20	3/4
020256B062	256	5/8	020440B100	440	1	020832B037	832	3/8	022520B087	1/4-20	7/8
020440B018	440	3/16	020632B018	440	3/16	020832B053	832	17/32	022520B100	1/4-20	1
020440B025	440	1/4	020632B025	632	1/4	020832B100	832	1	022520B106	1/4-20	1-1/16
020440B031	440	5/16	020632B037	632	3/8	021024B081	1024	3/16	022520B112	1/4-20	1-1/8

## LICENSE PLATE FASTENERS

### STANDARD

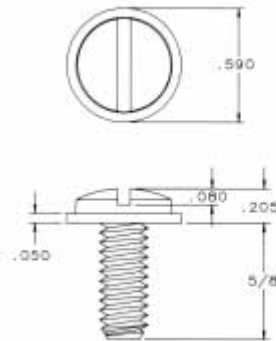

ITEM NUMBER

012520LP062

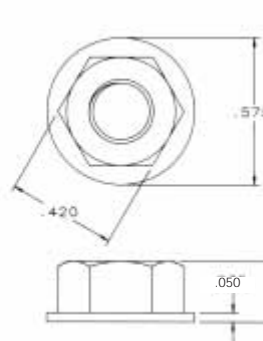

ITEM NUMBER

0425020LPN

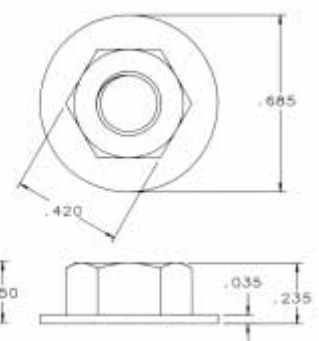

ITEM NUMBER

0425020LPNS

### STANDARD BOLT

### STANDARD NUT

### SPEC. STANDARD NUT

Part Number 60SGN01010LPS is a set of deluxe license plate fasteners packaged in a clear poly bag. Set includes two each of part number 60SGN01010 (grommet) and 011032W062ZP (zinc plated screw).

### DELUXE



ITEM NUMBER

011032W062ZP

### METAL SCREW

10-32 X 5/8" PHIL PAN



ITEM NUMBER

60SGN01010

### GROMMET



ITEM NUMBER

60SGN01010LPS

### FOUR PIECE SET



# SCREWS, BOLTS, AND THREADED ROD

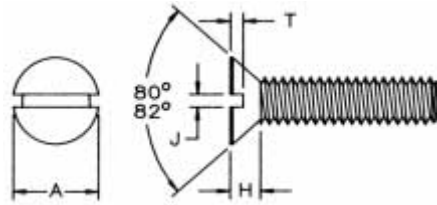

THREAD SIZE	A	H *Ref. Only	J	T
2	.147-.172	.051	.023-.031	.015-.023
4	.195-.225	.067	.031-.039	.020-.030
6	.244-.279	.083	.039-.048	.024-.038
8	.292-.332	.100	.045-.054	.029-.045
10	.340-.385	.116	.050-.060	.034-.053
12	.389-.438	.132	.056-.067	.039-.060
1/4	.452-.507	.153	.064-.075	.046-.070
5/16	.568-.635	.191	.072-.084	.058-.088
3/8	.685-.762	.230	.081-.094	.070-.106

## 82° FLAT HEADSTYLE

PART NUMBER	THREAD	LENGTH
020256A018	256	3/16
020256A025	256	1/4
020256A031	256	5/16
020256A037	256	3/8
020256A043	256	7/16
020256A050	256	1/2
020256A056	256	9/16
020256A075	256	3/4
020440A012	440	1/8
020440A015	440	5/32
020440A018	440	3/16
020440A025	440	1/4
020440A031	440	5/16
020440A037	440	3/8
020440A050	440	1/2
020440A056	440	9/16
020440A062	440	5/8
020440A075	440	3/4
020440A100	440	1
020440A112	440	1 1/8
020440A118	440	1 3/16
020440A125	440	1 1/4
020440A137	440	1 3/8
020440A150	440	1 1/2
020440A175	440	1 3/4
020448A015	448	5/32
020448A025	448	1/4

PART NUMBER	THREAD	LENGTH
020632A018	632	3/16
020632A025	632	1/4
020632A031	632	5/16
020632A037	632	3/8
020632A050	632	1/2
020632A062	632	5/8
020632A075	632	3/4
020632A100	632	1
020632A112	632	1 1/8
020632A125	632	1 1/4
020832A012	832	1/8
020832A025	832	1/4
020832A031	832	5/16
020832A037	832	3/8
020832A043	832	7/16
020832A050	832	1/2
020832A056	832	9/16
020832A062	832	5/8
020832A075	832	3/4
020832A100	832	1
020832A125	832	1 1/4
021024A050	1024	1/2
021024A075	1024	3/4
021024A100	1024	1
021032A025	1032	1/4
021032A031	1032	5/16
021032A037	1032	3/8

PART NUMBER	THREAD	LENGTH
021032A050	1032	1/2
021032A075	1032	3/4
021032A087	1032	7/8
021032A100	1032	1
021032A125	1032	1 1/4
021032A150	1032	1 1/2
022520A025	1/4-20	1/4
022520A050	1/4-20	1/2
022520A062	1/4-20	5/8
022520A075	1/4-20	3/4
022520A087	1/4-20	7/8
022520A100	1/4-20	1
022520A125	1/4-20	1 1/4
022520A150	1/4-20	1 1/2
022520A175	1/4-20	1 3/4
022520A200	1/4-20	2
022520A250	1/4-20	2 1/2
0231218A100	5/16-18	1
0237516A175	3/8-16	1 3/4



## SPECIAL ITEM 82° FLAT

ITEM NUMBER	401004
-------------	--------

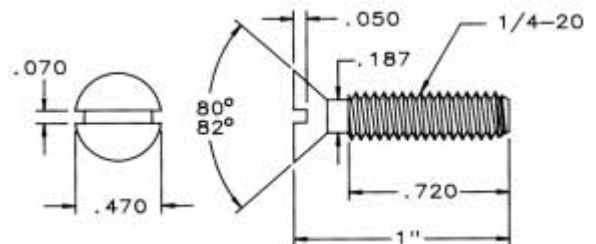



# SCREWS, BOLTS, AND THREADED ROD

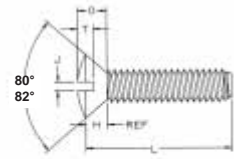

EDGE OF HEAD  
MAY BE FLAT  
OR BOUNDED

THREAD SIZE	A	* H	O	J	T
2	.147-.172	.051	.063-.080	.023-.031	.037-.045
4	.195-.225	.067	.084-.104	.031-.039	.049-.059
6	.244-.279	.083	.105-.128	.039-.048	.060-.074
8	.292-.332	.100	.126-.152	.045-.054	.072-.088
10	.340-.385	.116	.148-.176	.050-.060	.084-.103
12	.389-.438	.132	.169-.200	.056-.067	.096-.117
1/4	.452-.507	.153	.197-.232	.064-.075	.112-.136

## 82° OVAL

### HEADSTYLE

PART NUMBER	THREAD	LENGTH
330256A018	256	3/16
330256A025	256	1/4
330256A031	256	5/16
330256A037	256	3/8
330256A043	256	7/16
330256A050	256	1/2
330256A056	256	9/16
330256A075	256	3/4
330440A012	440	1/8
330440A015	440	5/32
330440A018	440	3/16
330440A025	440	1/4
330440A031	440	5/16
330440A037	440	3/8
330440A050	440	1/2
330440A056	440	9/16
330440A062	440	5/8
330440A075	440	3/4
330440A100	440	1
330440A112	440	1 1/8
330440A118	440	1 3/16
330440A125	440	1 1/4
330440A137	440	1 3/8
330440A150	440	1 1/2
330440A175	440	1 3/4
330448A015	448	5/32
330448A025	448	1/4

PART NUMBER	THREAD	LENGTH
330632A025	632	1/4
330632A031	632	5/16
330632A037	632	3/8
330632A050	632	1/2
330632A062	632	5/8
330632A075	632	3/4
330632A100	632	1
330632A112	632	1 1/8
330632A125	632	1 1/4
330632A175	632	1 3/4
330832A012	832	1/8
330832A025	832	1/4
330832A031	832	5/16
330832A037	832	3/8
330832A043	832	7/16
330832A050	832	1/2
330832A056	832	9/16
330832A062	832	5/8
330832A075	832	3/4
330832A100	832	1
330832A125	832	1 1/4
331024A050	1024	1/2
331024A075	1024	3/4
331024A100	1024	1
331024A125	1024	1 1/4
331032A025	1032	1/4
331032A031	1032	5/16

PART NUMBER	THREAD	LENGTH
331032A037	1032	3/8
331032A050	1032	1/2
331032A075	1032	3/4
331032A087	1032	7/8
331032A100	1032	1
331032A125	1032	1 1/4
331032A150	1032	1 1/2
332520A025	1/4-20	1/4
332520A050	1/4-20	1/2

PART NUMBER	THREAD	LENGTH
332520A062	1/4-20	5/8
332520A075	1/4-20	3/4
332520A087	1/4-20	7/8
332520A100	1/4-20	1
332520A125	1/4-20	1 1/4
332520A150	1/4-20	1 1/2
332520A175	1/4-20	1 3/4
332520A200	1/4-20	2
332520A250	1/4-20	2 1/2



# SCREWS, BOLTS, AND THREADED ROD

This versatile threaded rod stock is easily cut to size, resistant to most chemicals, electrically insulating, non-magnetic, lightweight, low thermal conductivity, vibration and abrasion resistant. Stock length is 2 feet. Longer lengths up to 8 feet available on special order.

We can furnish cut to your length with a nominal cutting charge.

Other plastic materials can be furnished on special order.

## THREADED RODS



ITEM NUMBER	DESCRIPTION	
3800440TR	440	Threaded Rod
3800632TR	632	Threaded Rod
3800832TR	832	Threaded Rod
3801024TR	1024	Threaded Rod
3801032TR	1032	Threaded Rod
3825020TR	1/4-20	Threaded Rod
3831218TR	5/16-18	Threaded Rod
3837516TR	3/8-16	Threaded Rod
3850013TR	1/2-13	Threaded Rod
3862511TR	5/8-11	Threaded Rod
3875010TR	3/4-10	Threaded Rod
3887509TR	7/8-9	Threaded Rod
3810008TR	1-8	Threaded Rod

## THREADED STUDS

Injection molded threaded studs with chamfer on both ends are available in several of the most popular sizes and lengths. Threaded studs are molded in natural Nylon 6/6 UL 94V2. These studs are resistant to most chemicals, electrically insulating, non magnetic, lightweight, low thermal conductivity, vibration and abrasion resistant.



LENGTH	TOLERANCE
3/4 " to 1"	+0 / - .03
1-1/2" to 2"	+0 / - .06
2 1/2" to 5"	+0 / - .09



ITEM NUMBER	DESCRIPTION		
3801032075SD	10-32	3/4	Threaded Studs
3801032100SD	10-32	1	Threaded Studs
3801032150SD	10-32	1 1/2	Threaded Studs
3801032200SD	10-32	2	Threaded Studs
3801032250SD	10-32	2 1/2	Threaded Studs
3825020075SD	1/4-20	3/4	Threaded Studs
3825020100SD	1/4-20	1	Threaded Studs
3825020150SD	1/4-20	1 1/2	Threaded Studs
3825020200SD	1/4-20	2	Threaded Studs
3825020250SD	1/4-20	2 1/2	Threaded Studs
3825020300SD	1/4-20	3	Threaded Studs
3831218100SD	5/16-18	1	Threaded Studs
3831218150SD	5/16-18	1 1/2	Threaded Studs
3831218200SD	5/16-18	2	Threaded Studs
3831218250SD	5/16-18	2 1/2	Threaded Studs
3831218300SD	5/16-18	3	Threaded Studs
3837516100SD	3/8-16	1	Threaded Studs
3837516150SD	3/8-16	1 1/2	Threaded Studs
3837516200SD	3/8-16	2	Threaded Studs
3837516250SD	3/8-16	2 1/2	Threaded Studs
3837516300SD	3/8-16	3	Threaded Studs
3837516400SD	3/8-16	4	Threaded Studs
3850013150SD	1/2-13	1 1/2	Threaded Studs
3850013200SD	1/2-13	2	Threaded Studs
3850013250SD	1/2-13	2 1/2	Threaded Studs
3850013300SD	1/2-13	3	Threaded Studs
3850013400SD	1/2-13	4	Threaded Studs
3850013500SD	1/2-13	5	Threaded Studs